

OWNER CERTIFICATE, DEDICATION AND RESERVATION
FOUNTAINGRASS ADDITION SECTION 3

40
I

Doc#:R 2007 10900
Bk&Pg:RB 3324 12-51
Filed:05-08-2007
03:42:37 PM
Canadian County, OK

JCE
RT

KNOW ALL MEN BY THESE PRESENTS:

THAT Vero Investments, LLC, Declarant, hereby certifies that it is the owner of, and the only person, firm or corporation having any right, title or interest in and to the following described real estate and premises situated in Canadian County, Oklahoma, to-wit:

All of FOUNTAINGRASS ADDITION SECTION 3, Oklahoma City, Canadian County, Oklahoma, according to the recorded plat thereof.

Said Declarant further certifies that it has caused the said property, designated aforesaid, to be surveyed into blocks, lots, streets and avenues, and has caused a plat to be made of said tract, showing accurate dimensions of lots, setback lines, rights-of-way, widths of streets and reserves for utilities (collectively the Properties or Addition). Said Declarant hereby dedicates to public use all the streets and avenues within such subdivision; easements for the installation and maintenance of drainage; and utility easements within the subdivision as shown on the recorded plat. All lands so dedicated to public use are free and clear of all encumbrances.

PROTECTIVE COVENANTS

For the purpose of providing an orderly development of the Properties, and for the further purpose of providing adequate restrictive covenants for the mutual benefit of said corporation and its successors in title to lots and blocks within the subdivision, it hereby imposes the following restrictions, covenants and reservations, and other documents of administration (individually the "Owner's Certificate" or "Declaration," collectively with the Articles of Incorporation, Bylaws, Rules and Regulations the "Governing Documents") to which it shall be incumbent upon successors in title to adhere.

1. All of the separately identified parcels and structures thereon (Lots or Units) according to the plat of FOUNTAINGRASS ADDITION, SECTION 3, of Oklahoma City, Oklahoma, shall be known as and reserved exclusively for use for residential single-family dwellings not to exceed 2 ½ stories in height, and with a garage capacity of not less than one automobile. A maximum of one single family dwelling unit may be constructed on each lot.
2. No building shall be erected, placed or altered on any building plot in this subdivision until the building plans, specifications and plot plan showing the location of such building have been approved in writing as to conformity and harmony of external design with existing structures in the subdivision, and as to the location of the building with respect to topography and finished grade elevation, by an Architectural Review Committee whose initial members shall be composed of Richard McKown, Vernon McKown and Mike Deskin, or by a representative designated by a majority of said committee, the remaining member or members shall have full authority to designate a successor or successors. In the event said committee, or its designated representative, fails to approve or disapprove, within thirty days, any plans and specifications submitted to it, or in any event, if no suit to enjoin construction has been commenced prior to the completion thereof, approval will not be required and this covenant shall be deemed to have been fully observed and complied with. Neither the members of such committee, nor its representative shall be entitled to any compensation for services pursuant to this covenant.
3. **Outbuildings.** No outbuildings shall be permitted on any lot adjoining a Common Area where such outbuilding would be visible from the Common Area. Any structure not the single residence constructed on a Unit shall receive prior Architectural Review

Return: Vero Investments, LLC
1320 N. Postle
Norman, Ok. 73071

Committee approval. Metal outbuildings are permitted provided they are less than 6 feet tall at the peak of the outbuilding roof and provided no part of the outbuilding is visible from any street, any lot, or the Common Areas. Outbuildings taller than 6 foot at the peak of its roof are permitted provided such outbuilding is of the same style, material, and size as that depicted in Exhibits “A”, “B”, “C”, “D” attached and made a part hereof. All outbuilding roofs must be shingled with the same shingles as installed on the residence, and the color of the outbuilding must match the trim color of the residence. All outbuildings shall be located within any City set back ordinance as well as any set back provided by any Governing Document. Each outbuilding shall be properly permitted as required by City ordinance.

4. No building shall be located on any lot neither nearer to the front lot line nor nearer to the side street line than the minimum building setback lines shown on the recorded plat. In any event, no building shall be located on any residential plot nearer than twenty feet to the front lot line, or further than thirty-five feet from the front lot line, or nearer to the rear lot line than permitted by city ordinances. No dwelling shall be located nearer than five feet to a side lot line. In no event shall the distance between a single-family residential building be less than ten feet. For the purpose of this covenant, eaves, steps and open porches shall not be constructed to permit any portion of a building on a lot to encroach upon another lot.
5. Reserves for installation and maintenance of utilities and drainage facilities are reserved as shown on the recorded plat. Within these utility reserves no structure, planting or other material shall be placed or permitted to remain which may damage or interfere with the installation and maintenance of utilities, or which may change the direction of flow of drainage channels in the utility reserves, or which may obstruct or retard the flow of water through drainage channels in the utility reserves. The utility reserve area of each lot and all improvements permitted therein for those improvements for which a public authority or utility company is responsible. All small drainage channels, emergency overflows, and other swales which are important to abutting properties, but are not a part of the drainage system maintained by public authority or utility company, shall be the property owner's responsibility; and it shall be the responsibility of the property owner to (A) keep the easements, channels and swales free of any structure, planting or other material which may change the direction of flow, obstruct, or retard the flow of surface water in the channels or swales whether they be in easements or contained on the individual property owner's lot and (B) to provide continuous maintenance of the improvements in the easements or of the channels or swales, except for the improvements for which a public authority, utility company, or property-owner's maintenance association is responsible.
6. Leasing of Units. **“Leasing, leased, and lease”** for purposes of this Section, is defined as regular, exclusive occupancy of a Unit by any person, other than the Owner of which the Owner receives any consideration or benefit, including, but not limited to, a fee, service, gratuity, or emolument. **“Owner Occupied Units”** are defined for purposes of this Paragraph as Units occupied solely by the Owner, the members of the family of the Owner or other guests and invitees of the Owner who occupy without the payment of rent, as the occupant's principal residence or second home. **“Professional Manager”** shall mean a person or entity that Professionally Manages residential real estate within the United States and has each of the following qualifications 1) If an individual, is a licensed real estate broker within the State of Oklahoma, and has been so licensed for a period of no less than three (3) years from the date such person seeks to manage a Leased Lot/Unit within the Addition; or if an entity, the controlling interest in such entity is owned by at least one person who is a licensed real estate broker within the State of Oklahoma, and has been so licensed for a period of no less than three (3) years from the date such entity seeks to manage a Leased Lot/Unit within the Addition, and 2) Currently and continually Professionally Manages no less than five residential real estate properties within the State of Oklahoma, and 3) Has Professionally Managed residential real estate no less than three (3) years prior to the date the Professional Manager seeks to manage a Leased Lot/Unit. **“Professionally Manage”** shall mean the administration, oversight, management or control of residential real estate by a Professional Manager.

6.1 Leasing Restricted. Within the Properties, Units may be leased, provided the total percentage of leased Units within the Properties shall not exceed ten percent (10%) of the total number of Units within the Properties. Upon the occurrence of a decrease below 10% of Owner Occupied Units within the Properties, Units will be permitted to be leased on a first bona fide request, first permitted basis, until the number of units which are leased reaches 10%, at which time no further Units shall be leased until the number of leased Units drops below 10%. Except for the Declarant, if a single entity (the same individual, investor group, partnership, or corporation) owns more than 5% of the total Units, no Unit in excess of 5% of the total Units within the Properties which it (a) owns and occupies as their residence and (b) leases, may be leased. In order to administer the above regulation, all Persons who intend to purchase a Unit within the Properties shall file a certification with the Association (a) that the Unit will not be occupied as the purchaser's principle residence or second home, or (b) covenanting and agreeing with the Association that the purchaser will occupy the Unit as an Owner Occupied Unit until the leasing restriction under this Section is lifted. The Association will keep a record of the Owner Occupied Units and leased Units. Each lease shall be for a term of no less than 12 months and each lessee shall expressly agree to the terms of the Governing Documents.

6.2 Leased Lot/Unit Restrictions and Requirements.

6.2.1 **Professional Management.** Each Leased Lot/Unit shall be Professionally Managed.

6.2.2 **Registration.** Prior to the date any Lot/Unit shall become a Leased Lot/Unit, each Professional Manager shall register the following with the Association: 1) Name, business address, telephone and facsimile numbers, and email address for the individual Professional Manager; 2) Professional Manager entity name, state of organizations, and date formed, business address, telephone and facsimile numbers, and email address for the entity Professional Manager; 3) Date began property management of residential real estate; 4) Maximum/minimum number of leased residential properties managed within the past 12 months; 5) Five representative property address references and contacts; 6) Photocopies of all residential real estate licenses held by the owners, employees, and agents of Manager, including: license issuing agency, date license was obtained, and a certification by the license holder that such license is current and in effect as of the date such license holder seeks to become qualified as a Professional Manager; 7) Demonstrate compliance with all licensing, ordinances, and code for any structure located on the Leased Lot/Unit; and 8) Demonstrate adequate insurance coverage, including but not limited to 1) liability and casualty on each structure located on the Leased Lot/Unit, and 2) worker's compensation on the Professional Manager.

6.3 **Familiarity with Governing Documents.** Each Professional Manager, their staff, employees, and agents shall demonstrate a familiarity with the Governing Documents to the Addition and shall agree to review the same with each tenant, lessee, or occupant.

6.4 **Community-Wide Standard.** Each Professional Manager and Leased Lot/Unit Owner shall acknowledge the existence of the Community Wide Standard within the Addition and shall expressly agree that the Leased Lot/Unit shall be maintained within such standard, each personally agreeing to bear any expense incurred by the Declarant and Association in bringing the Leased Lot/Unit into compliance with the Governing Documents and Community Wide Standard.

6.5 **No Joint Venture or Partnership.** The Owner of any Leased Lot/Unit and Professional Manager shall not be considered any partner, employee, agent or joint venturer with the Declarant or Association and no term within this Amendment shall create any implication or presumption of such relationship. No Owner of a Leased Lot/Unit or Professional Manager shall hold themselves or any other out to be any partner, employee, agent or joint venturer with the Declarant or Association.

6.6 Leased Lot/Unit Sign Restrictions. Each Owner and Professional Manager shall comply with any applicable sign restriction contained within the Governing Documents, including any rules adopted by the Architectural Review Committee.

7. No business or trade activity shall be carried on upon any residential lot. No noxious or offensive activity shall be carried on upon any lot, nor shall anything be done thereon which may be or may become an annoyance or nuisance to the neighborhood.
8. No structure of a temporary character, trailer, basement, tent, shack, garage, barn, or other outbuilding shall be used on any lot at any time as a residence either temporarily or permanently.
9. The minimum square foot area requirements for structures in FOUNTAINGRASS ADDITION, SECTION 3, shall be Eight Hundred Square Feet. This minimum figure is for living space and is exclusive of garages, covered porches and breezeways.
10. All fencing, except as indicated below, shall be 6-foot wood, dog-eared privacy fencing constructed with the smooth side facing outward to the common areas, public streets, and any open areas developed or not. No fence shall be installed on the front portion of any lot between the front lot line and the front building set back line. **Fencing may not be painted, but may be stained a light cedar color with prior approval of the Architectural Review Committee.**
 - A. On the following corner lots (Lots 1, 11 Block 13; Lot 1, Block 14; Lot 1, Block 15; Lot 1, Block 16) the side lot fence shall be 21 feet from the back of the curb.
 - B. The fencing across the backs of Lots 1-19, Block 20 shall be 4 foot high dog-eared stockade fencing with every other picket removed.
 1. With prior approval of the Architectural Review Committee, owners may attach 4 foot tall black vinyl coated chain link fencing to the inside of said fencing.
 2. The maintenance and replacement of the fencing across the backs of Lots 1-19, Block 20 is the responsibility of the Fountaingrass Property Owner's Association. In that regard, the Association shall, at all times and with reasonable notification, have a perpetual easement to enter upon individual lot owner's property for the purpose of maintenance or replacement of said fencing.
 3. Under no circumstance will an owner paint or stain the fencing across the back of Lots 1-19, Block 20.
 - C. Any deviations to these fencing requirements must be approved by the Architectural Review Committee.
11. The maintenance and replacement of the screening fencing along Southwest 29th Street is the responsibility of the Fountaingrass Property Owner's Association. In that regard, the Association shall, at all times and with reasonable notification, have a perpetual easement to enter upon individual lot owner's property for the purpose of maintenance or replacement of said screening fencing.
12. No outbuilding shall be permitted in any easement reserved for utilities.
13. No animals, livestock or poultry of any kind shall be raised, bred or kept on any lot, except that dogs, cats or other household pets may be kept, provided they are not kept, bred or maintained for any commercial purposes.
14. No sign of any kind shall be displayed to the public view on any lot except one professional sign if not more that six square feet or one sign or signs used by a builder to advertise the property during the construction and sale period. Any deviation to this restriction must be approved by the Architectural Review Committee.

15. All the roofs shall be completed using shingles with a minimum weight of 185 pounds per square and shall be "weatherwood" (gray in color) or the equivalent. The roofs must have a minimum pitch slope of 4 to 12. All other roofs must be approved by the Architectural Control Committee.
16. The principle exterior of any residential structure shall be brick. Any deviation from this restriction must be approved by the Architectural Review Committee.
17. **All residences shall be of new construction, and no residence, part of a residence, or garage, may be moved from another area into this subdivision. Mobile homes, of any kind, shall not be allowed to be placed or parked, either permanently or temporarily, on any lot. (Garage conversions are prohibited.)**
18. All lots are to be landscaped in a style in keeping and in harmony with the area and as approved by the Architectural Review Committee. All garbage cans or refuse areas are to be fully screened and covered from view from the street and from adjoining lots.
19. **Lawn Maintenance Standard.** Each Owner shall maintain the landscaping on their Lot, including structures, vegetation, lawn, and beds in a neat, orderly, and well-manicured manner (the Lawn Maintenance Standard). The Lawn Maintenance Standard shall include, but shall not be limited to: reasonable seasonal mowing, trimming, and edging of any yard and bed, trimming shrubs and bushes, and removal of dead vegetation. The Architectural Review Committee shall have exclusive oversight over whether a Lot meets the Lawn Maintenance Standard.
20. No truck, boat, bus, camper, trailer, recreational or commercial vehicle of any kind or any motor vehicle other than a standard passenger vehicle such as automobile, pickup truck, van or SUV shall be parked or permitted to remain on the driveway of, or yard of, any residential plot in the subdivision, except for such period of time as may be absolutely necessary in order to pick up or deliver materials or to do work or make repairs on the property. It is the intent of this requirement that the owners and occupants of residential buildings in the subdivision shall not use the property upon which they reside, for the storage or habitual parking of any such prohibited motor vehicle, other than the said standard passenger vehicle such as automobile, pickup truck, van or SUV.
21. No trash, ashes or other refuse may be thrown or dumped on any vacant lot. Each owner of a vacant lot is required to keep said lot in presentable condition or the Committee may, at its discretion, mow said lot, trim and spray trees, remove trash or refuse and levy a lien on said lot for the cost involved. Any non-burnable refuse must be hauled away for disposal. No owner may make use of a vacant lot for dumping, burning or otherwise disposing of refuse.
22. No owner of any lot within said addition shall demand or receive electric service from overhead wire facilities so long as electric service is available from underground distribution systems. The owner of each lot shall provide the required improvements erected thereon by means of underground service conductors installed, owned and maintained in accordance with plans and specifications furnished by the electric service supplier leading from the source of supply in the utility reserve to such improvement. In addition, no aboveground tank shall be installed or placed on the property, nor shall there be any antennas, transmission towers, etc., without written consent from the Architectural Review Committee.
23. In addition to specific amendment rights granted elsewhere in this Declaration and without restriction by any term within this Declaration, as long as Declarant owns one lot in Fountaingrass Addition Section 3, Declarant may unilaterally amend this Declaration for any purpose. Thereafter, Declarant may unilaterally amend this Declaration if such amendment is necessary (i) to bring any provision into compliance with any applicable governmental statute, rule, regulation, or judicial determination; (ii) to enable any reputable title insurance company to issue title insurance coverage on the Units; (iii) to enable any institutional or

governmental lender, purchaser, insurer or guarantor of mortgage loans, including, for example, the Federal National Mortgage Association or Federal Home Loan Mortgage Corporations, to make, purchase, insure or guarantee mortgage loans on the Units; or (iv) to satisfy the requirements of any local, state or federal governmental agency. Any such amendment shall not adversely affect the title to any Unit unless the Owner shall consent in writing. In addition, so long as Declarant owns one lot in Fountaingrass Addition Section 3, it may unilaterally amend this Declaration for any other purpose, provided the amendment has no material adverse effect upon any right of any Owner.

24. Except as otherwise specifically provided above and elsewhere in this Declaration, this Declaration may be amended only by the affirmative vote or written consent of seventy five percent (75%) of the owners of the lots, and the consent of the Declarant so long as Declarant owns any property subject to this Declaration. Notwithstanding the above, the percentage of votes necessary to amend a specific clause shall not be less than the prescribed percentage of affirmative votes required for action to be taken under that clause.
25. No amendment may remove, revoke, or modify any right or privilege of Declarant without the written consent of Declarant (or the assignee of such right or privilege). If an Owner consents to any amendment to this Declaration, it will be conclusively presumed that such Owner has the authority to consent, and no contrary provision in any Mortgage or contract between the Owner and a third party will affect the validity of such amendment. Any amendment shall become effective upon Recording, unless a later effective date is specified in the amendment. Any procedural challenge to an amendment must be made within six months of its Recordation or such amendment shall be presumed to have been validly adopted. In no event shall a change of conditions or circumstances operate to amend any provisions of this Declaration.
26. The covenants and restrictions of this Declaration shall run with and bind the Property, for a term of twenty (20) years from the date this Declaration is recorded, after which time they shall be automatically extended for successive periods of ten (10) years unless, prior to the expiration of the then current term, a written instrument shall be executed by the then owners of ninety percent (75%) of the lots stating that this Declaration shall expire at the end of the then current term.
27. Each owner shall register in writing his mailing address with the Association, and notice or demands intended to be served upon an owner shall be sent by certified mail, postage prepaid, address in the name of the owner at such registered mailing address. All notices, demands or other notices intended to be served upon the Association governing these restrictions shall be sent certified mail, with postage prepaid to 1320 N. Porter, Norman, Oklahoma 73071.
28. **If the undersigned party, or any of its successors or assigns, or any person or persons claiming under them, shall violate any of the covenants herein, it shall be lawful for any other person or entity owning any real property situated in this subdivision to prosecute any proceedings at law or in equity against the party or entity violating or attempting to violate any such covenant, and either to prevent him or them from so doing or to recover damages or other dues for such violation, including attorneys fees in the prosecution and enforcement of said covenants.**
29. Certain restrictions addressing trailers, fencing, garage conversions, landscaping, use of property, driveways, and signage contained in this document do not apply to those lots on which model homes may be constructed for sales purposes. Upon termination of their use as sales models, these structures will be converted to single family use and comply with all the restrictions in this document.
30. Invalidation of any one of these covenants by judgment or court order shall in no wise affect any of the other provisions herein, and such other provisions shall remain in full force and effect.

31. The property contained herein will be made a part and parcel of a certain Declaration of Property Owners Association to be filed with the County Clerk of Canadian County, with Fountaingrass Property Owners Association, Inc., a non-profit corporation, having the right and obligation to enforce these restrictions.

Dated this 16th day of April, 2007.

VERO INVESTMENTS LLC

[Signature]
Richard McKown, Manager

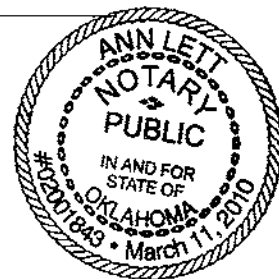

STATE OF OKLAHOMA)
)
COUNTY OF CLEVELAND)

SS

The foregoing instrument was acknowledged before me this 16th day of April, 2007, by Richard McKown, Manager of Vero Investments, LLC.

My Commission Expires: 3/11/10

[Signature] Notary Public
#02001843

8' Marco Series Gambrel Building

Engineering Building
Plans for 8x8

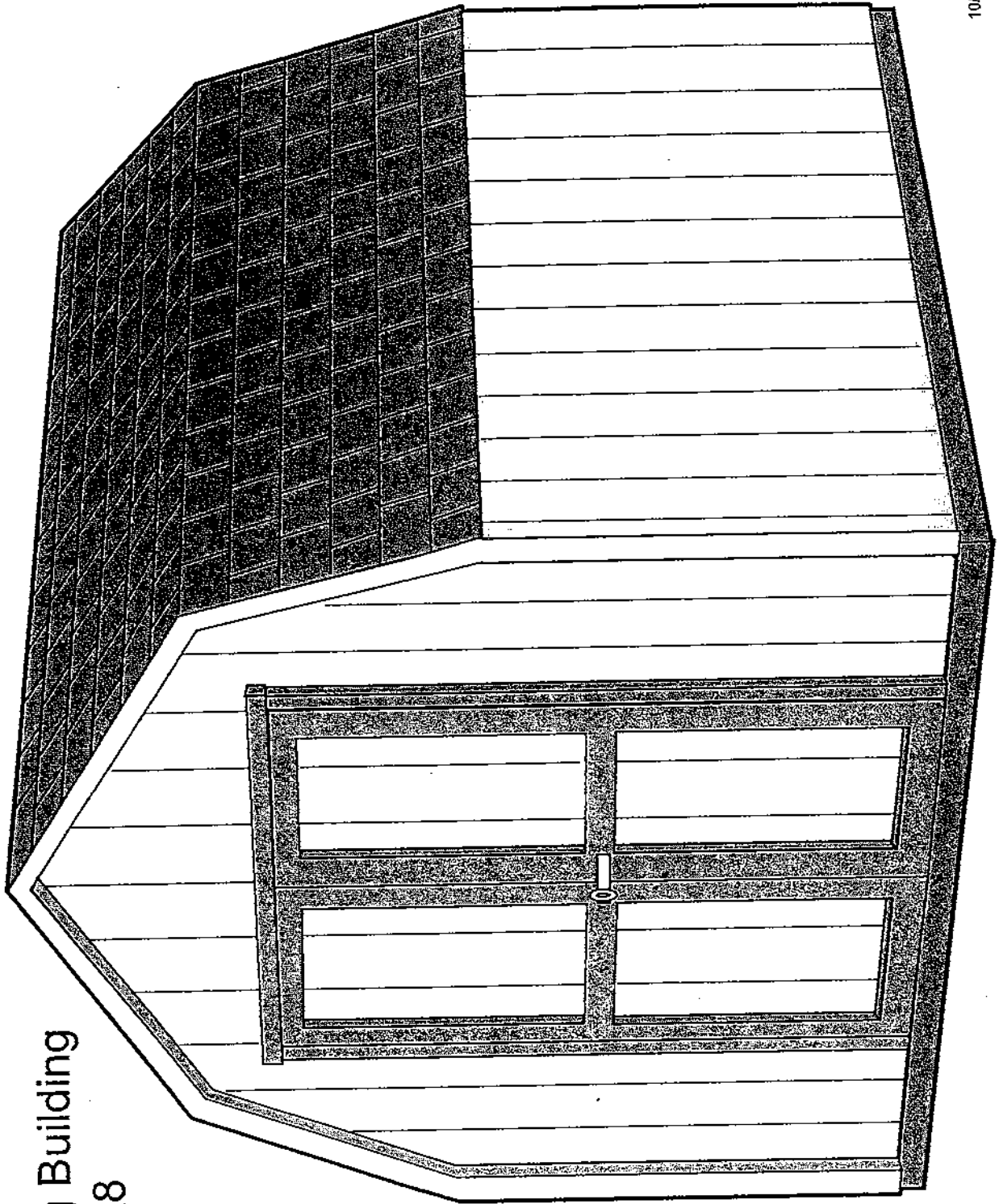

107/03

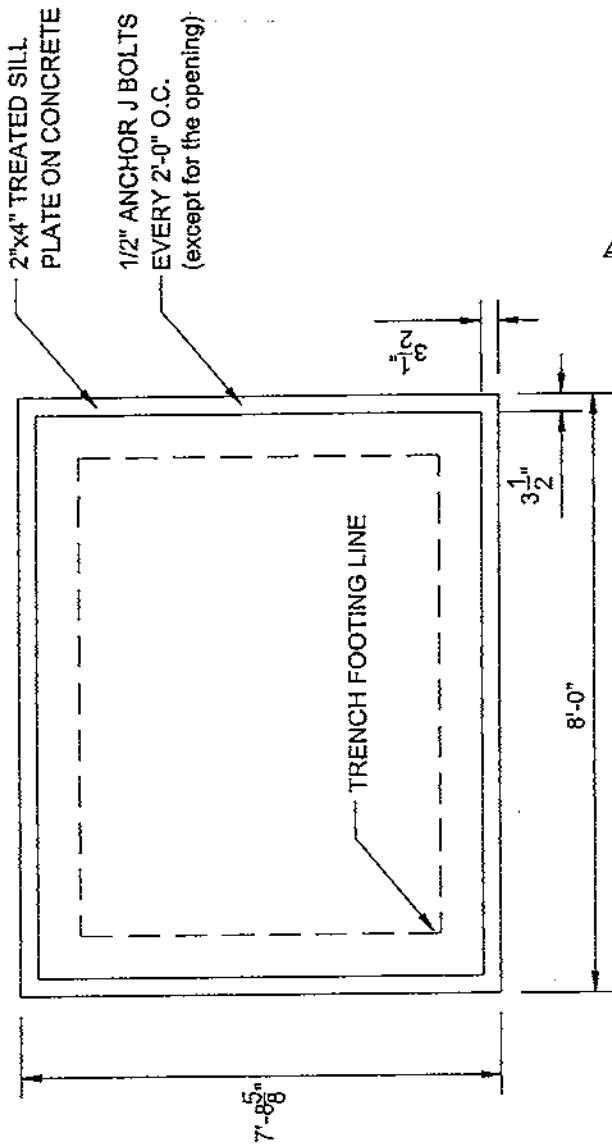

SLAB LAYOUT

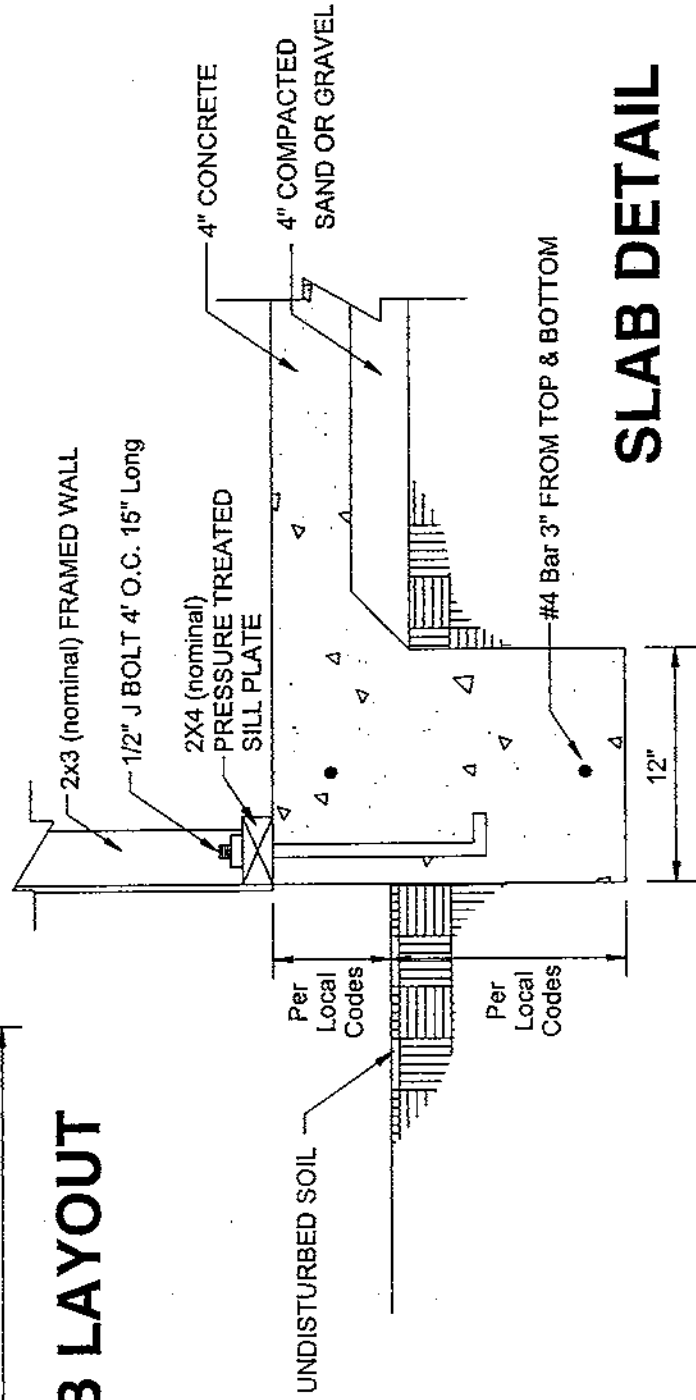

SLAB DETAIL

NOTE:

1.) ONLY THE PIERS INDICATED WITH SP ARE
REQUIRED TO HAVE SIMPSON STRONG TIES

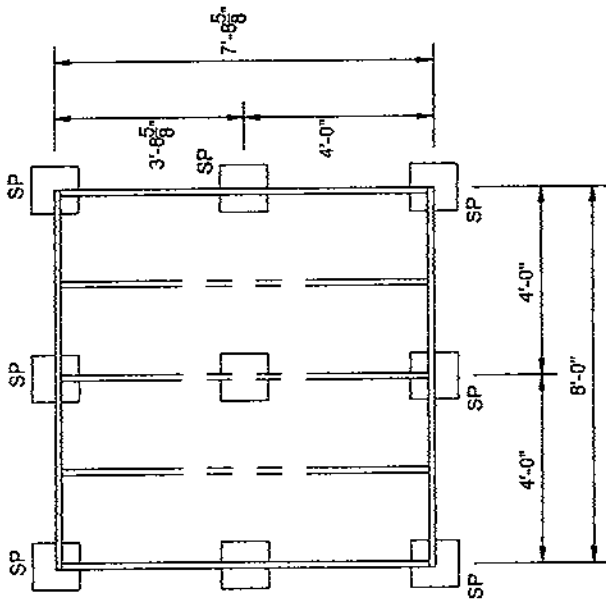

WOOD FLOOR LAYOUT

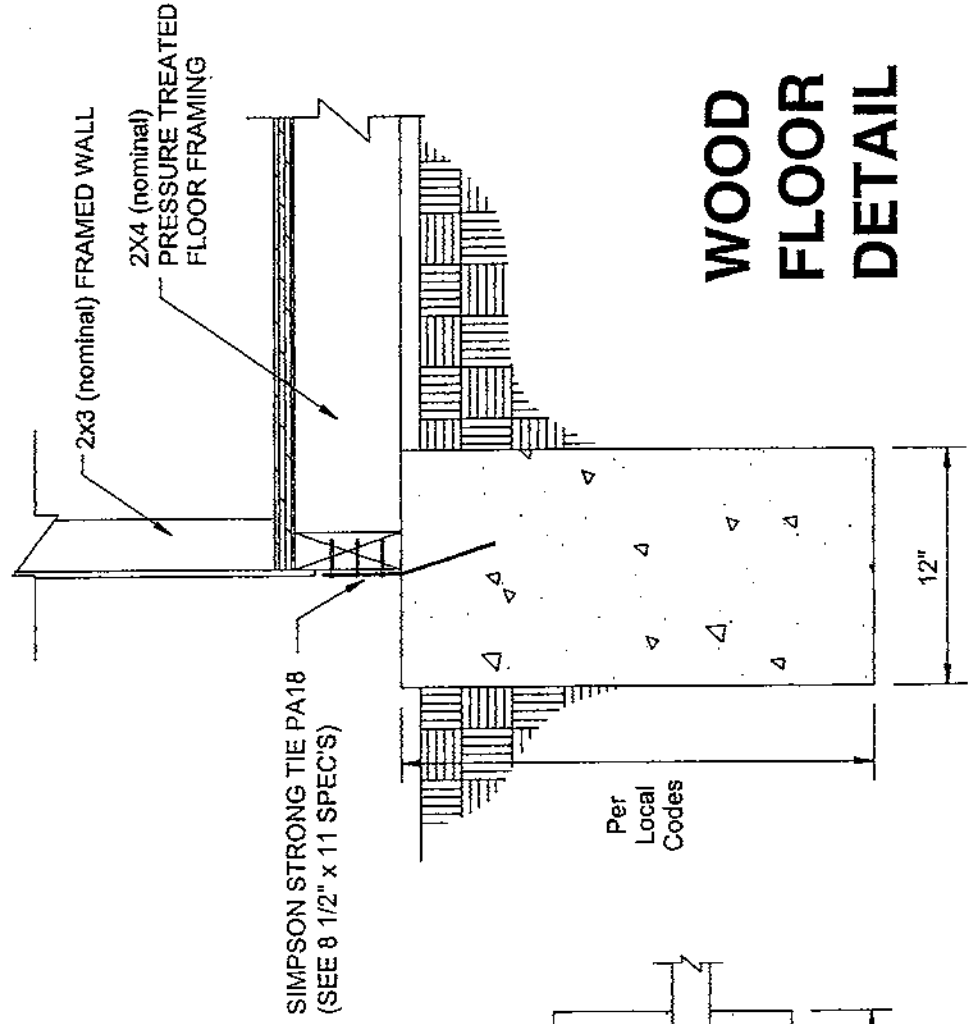

WOOD FLOOR DETAIL

SIMPSON STRONG TIE PA18
(SEE 8 1/2" x 11 SPEC'S)

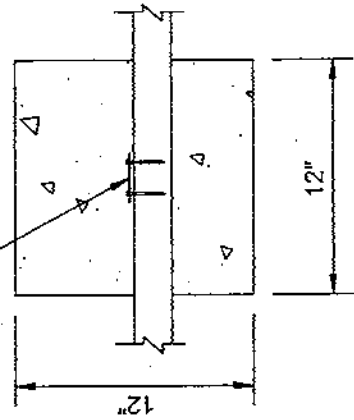

PLAN DETAIL

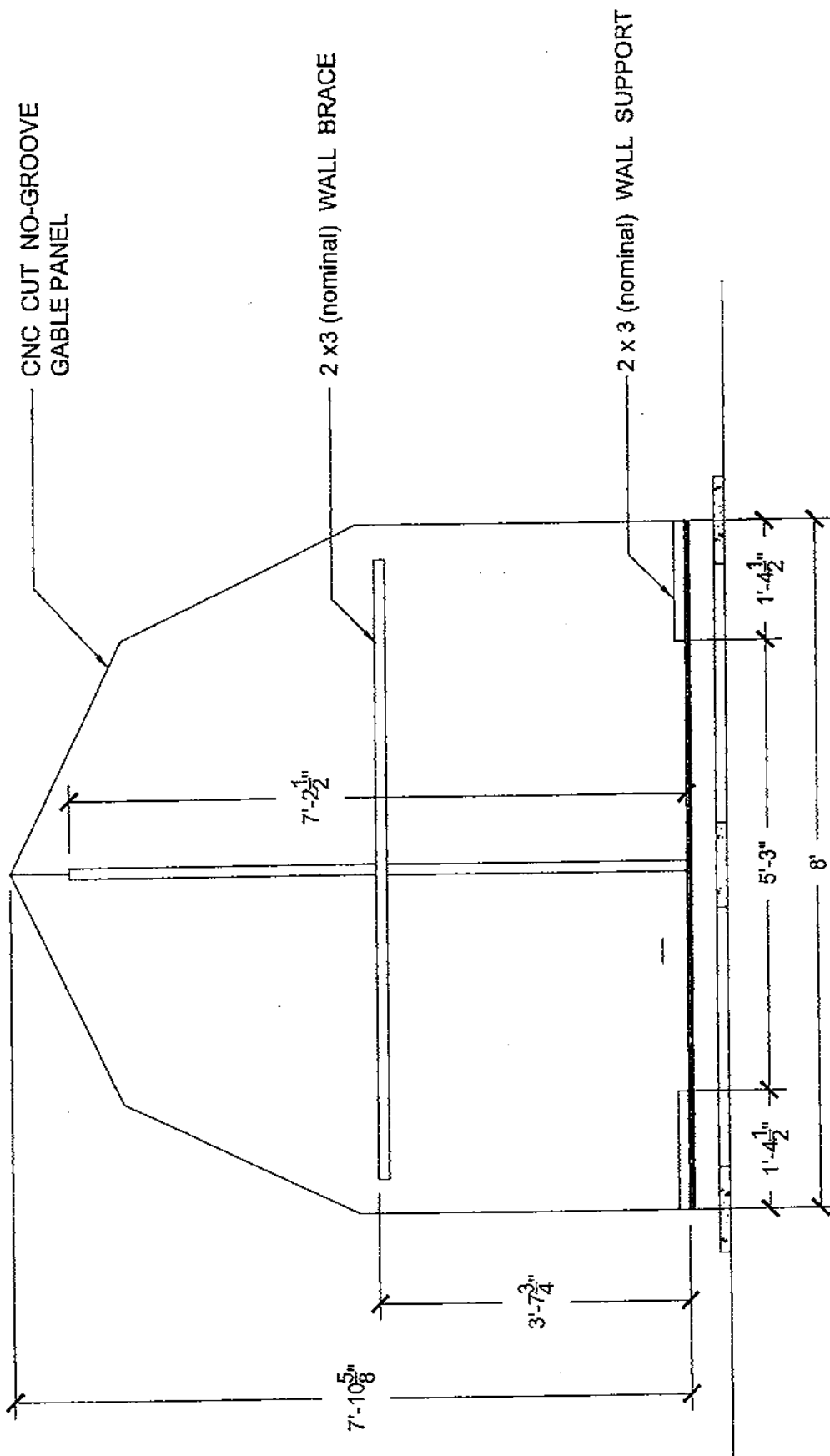
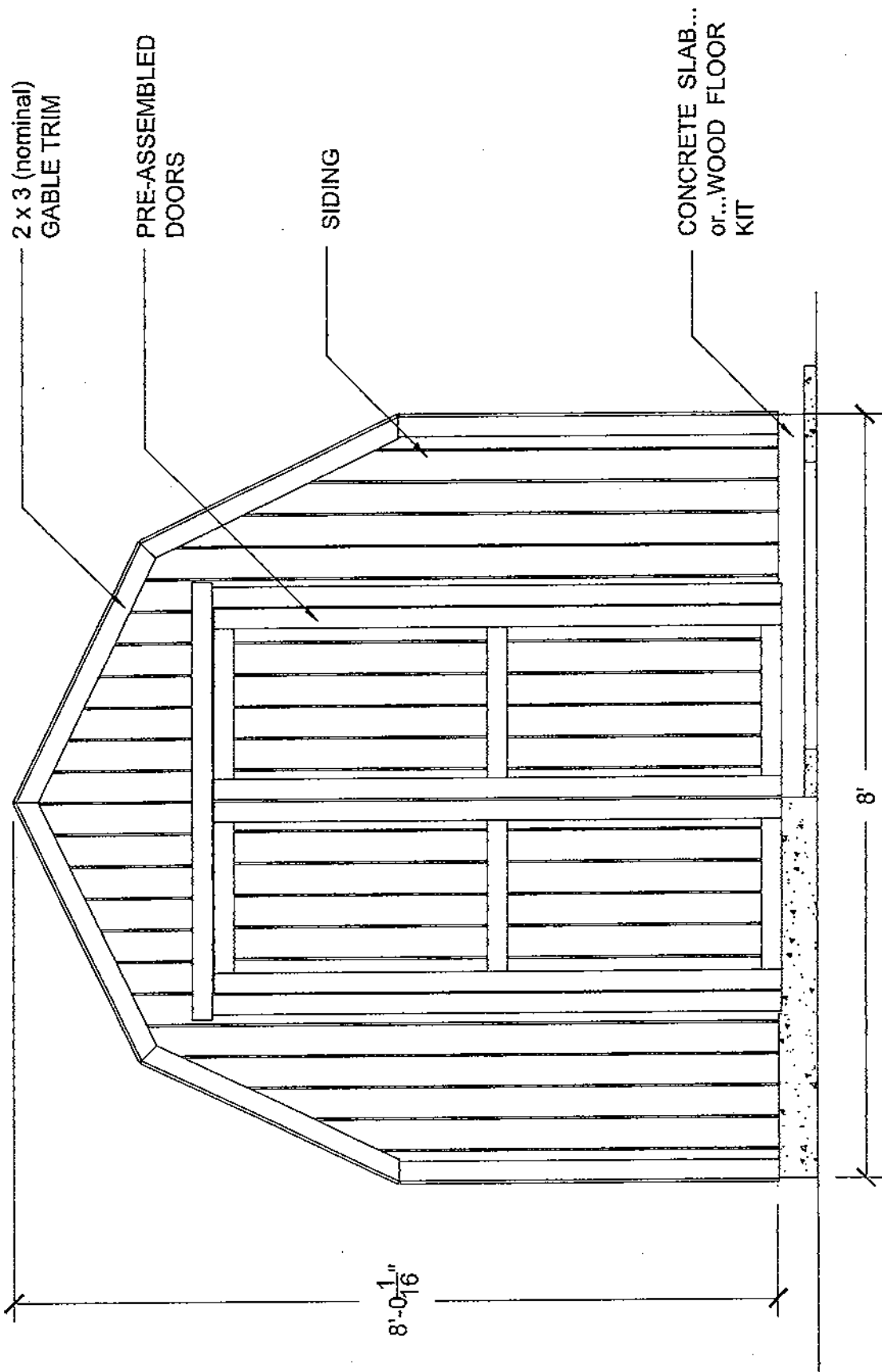
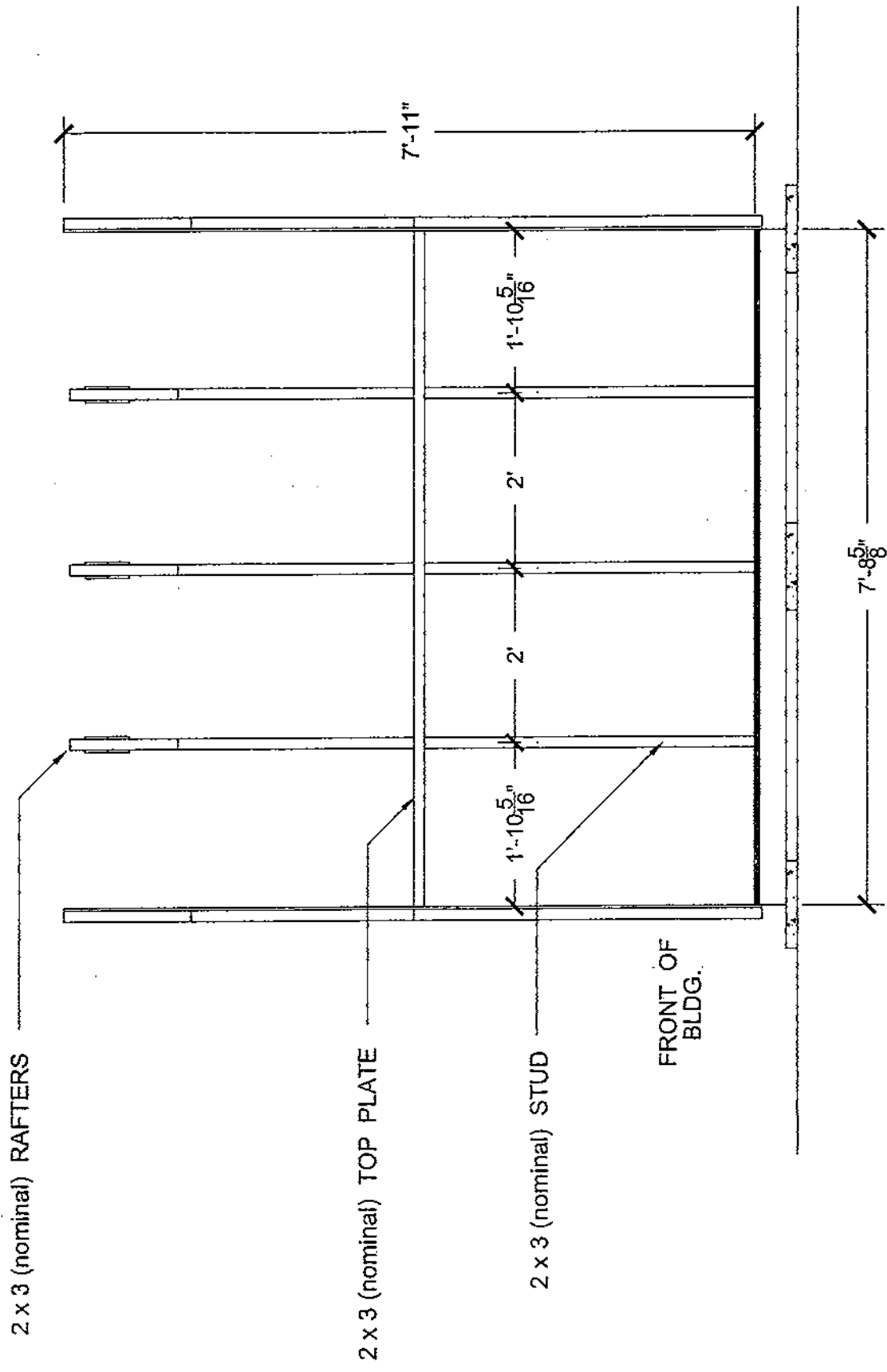

Exhibit A 4 of 8

BACK WALL FRAMING



FRONT ELEVATION



SIDE FRAMING

(2) 3/8" GUSSETS ... Fastened
With (10) 2" Nails & (2) Beads
Of Exterior Wood Glue

2 x 3 (nominal) RAFTERS
3/8" ROOF PANEL

SECURE TRUSSES with (2) 3"-16d
NAILS TOE-NAILED INTO TOP PLATE

2 x 3 (nominal) TOP PLATE

2 x 3 (nominal) STUD
SIDING

WOOD FLOOR WITH
APPROVED ANCHORS

SECTION

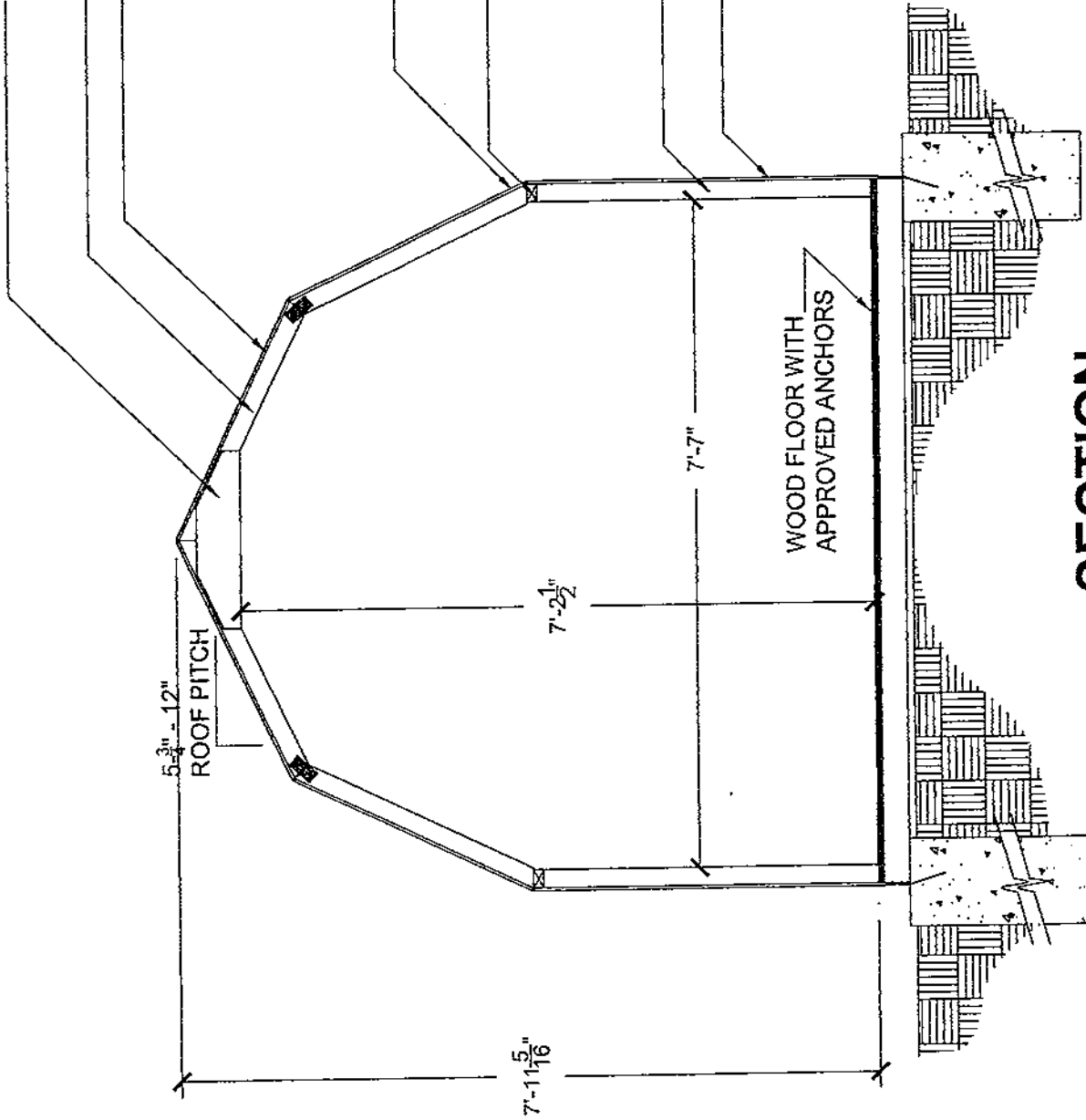

- NOTES: 1) The Roof System of this 8 ft. wide Gabrel style building has a live load capacity of 35 PSF. The equivalent ground snow load per ANCE 7-97 is 68 PSF which exceeds the 16.2 PSF pressure for a 110 mph wind per ASCE 7-97.
- 2) This plan supplements assembly instructions.

STRUCTURAL ANALYSIS:

f b = 1200 PSC
 f v = 80 psi
 Sx 2"x3" = 1.56 in Area = 3.75 in

DEAD LOAD:
 Max Rafter Moment = fb Sx/12=156 ft.lb.
 Max Rafter Shear = 80x3.75=300 lb.
 Max Stud Moment = 156 ft. lb.

ROOF SYSTEM:

1) Rafters 2x3@2'cc w=8M/L2 = 78PLF=39 PSF-4
 2) Rafter Shear w=2V/L = 150 PLF=75 PSF-4
 3) Sheathing w=49PSF-4=45psf
 4) Ground Snow Load: Ref ASCE 7-97
 Ps=35PSF I=0.8
 Cs=0.95 Ce=0.8
 Ct=1.2 Pf=35/0.95=36PSF
 Pg=PF/7.CeCtI=68 PSF Ground Snow Capacity

WALL SYSTEM:

1) Studs 2x3@24"cc L=3.3ft. w=8M/L2=114PLF=57 PSF
 2) Wind Loading V = 110 mph EXP 1
 Kz=0.37 Gh=1.65 GCpf=-0.25
 I=0.95 Cp=0.8
 Velocity Pressure=8z=.00256Kz(IV) =10.3PSF
 Design Pressure=P=qfGhCp-(qhGCpl)=16.2PSF
 ok<57PSF

8' Marco Series Gable Building

Engineering Building
Plans

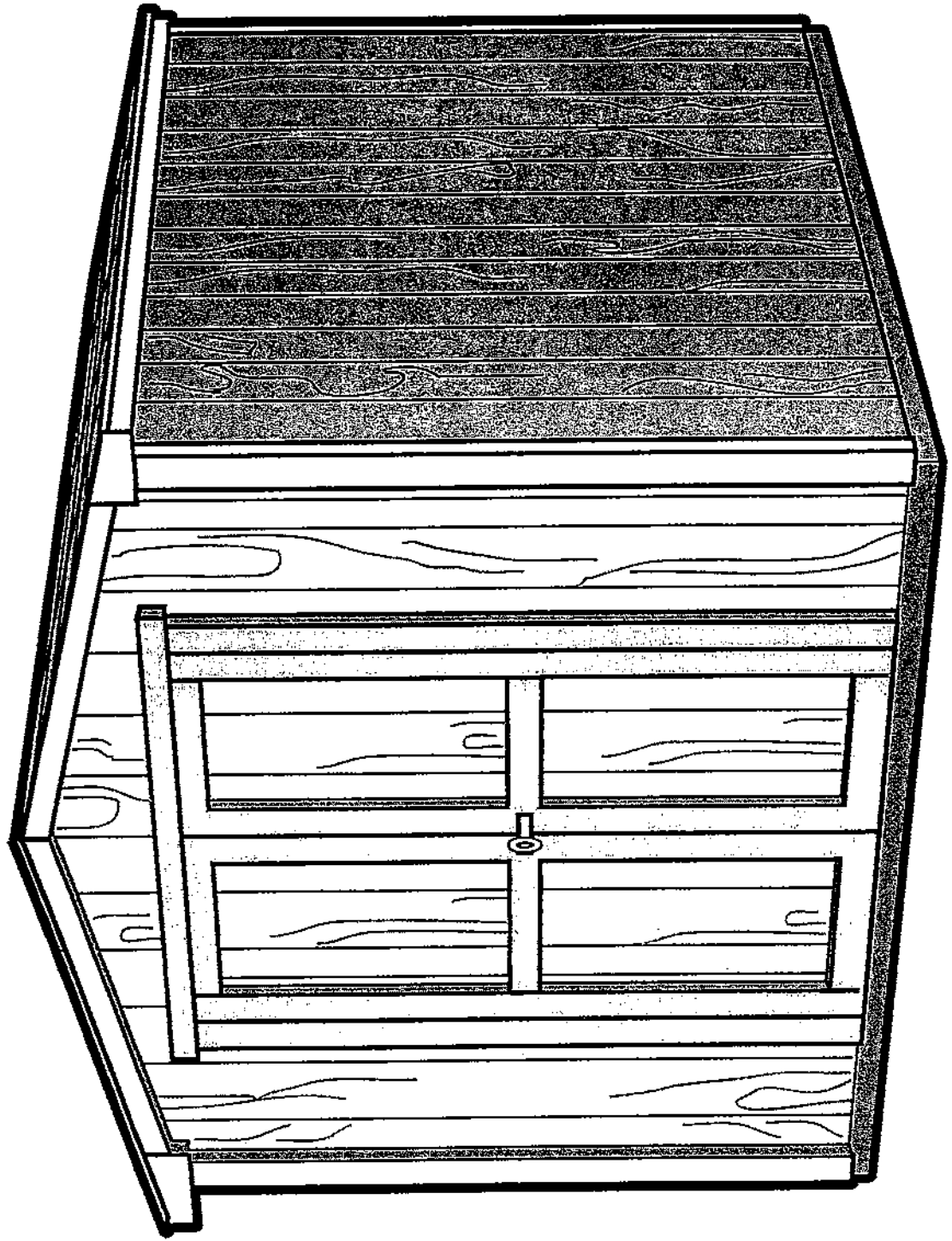

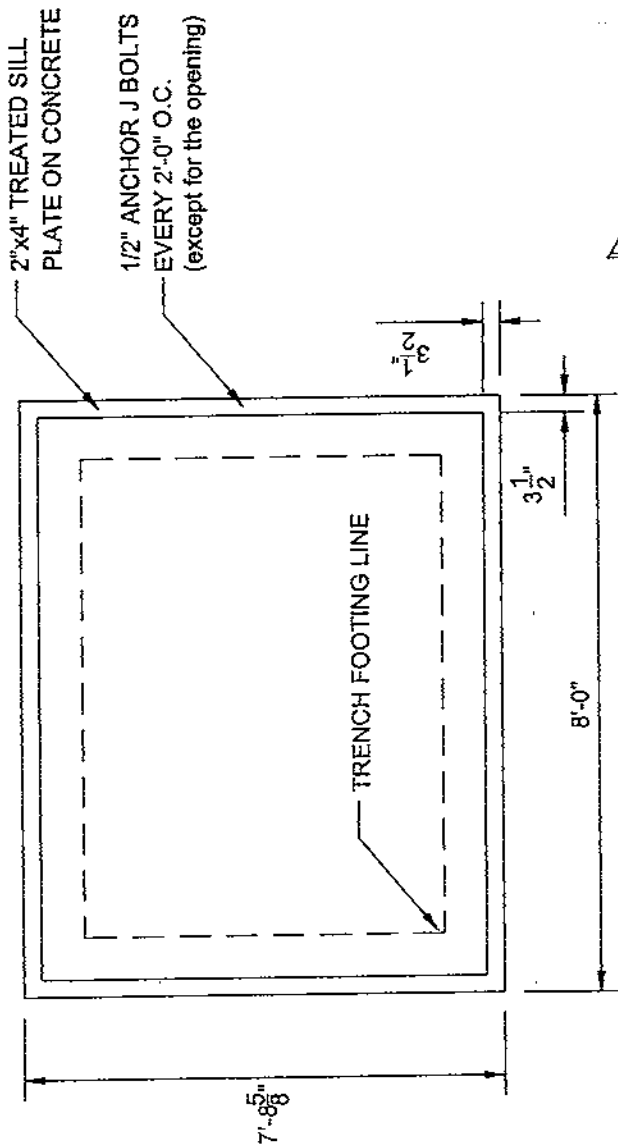

SLAB LAYOUT

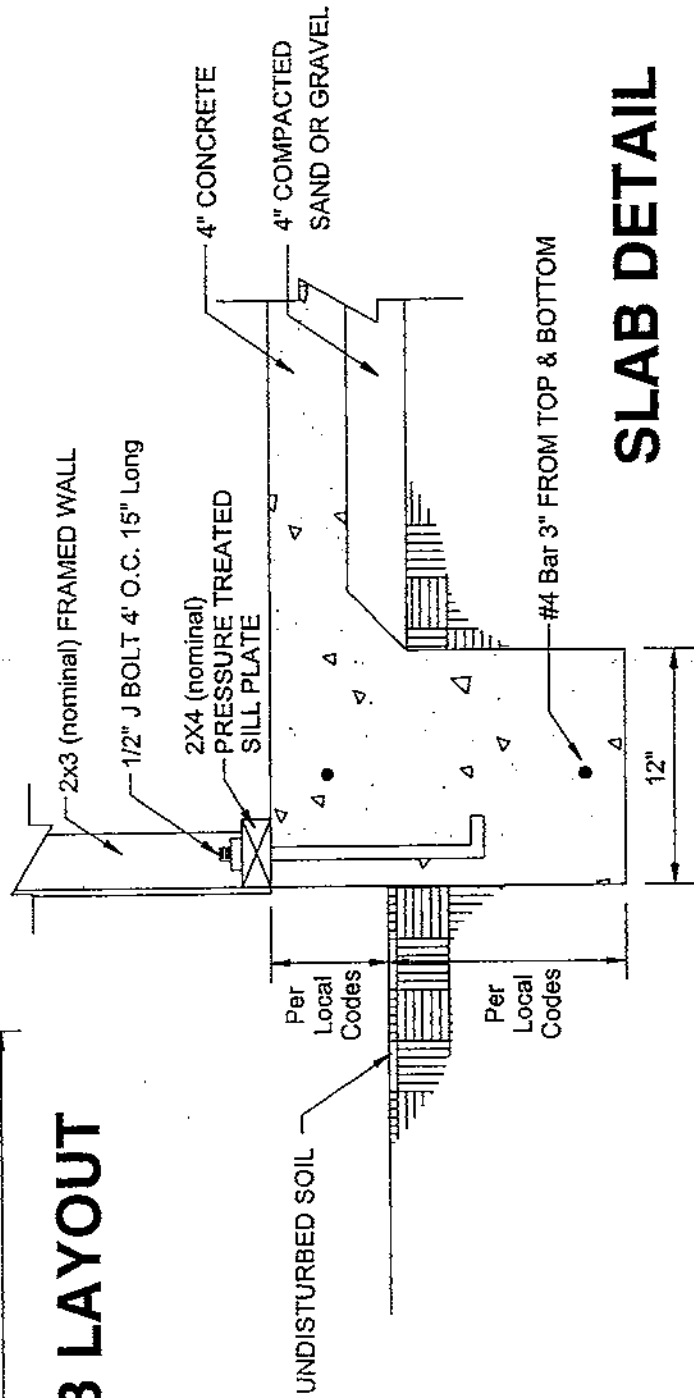

SLAB DETAIL

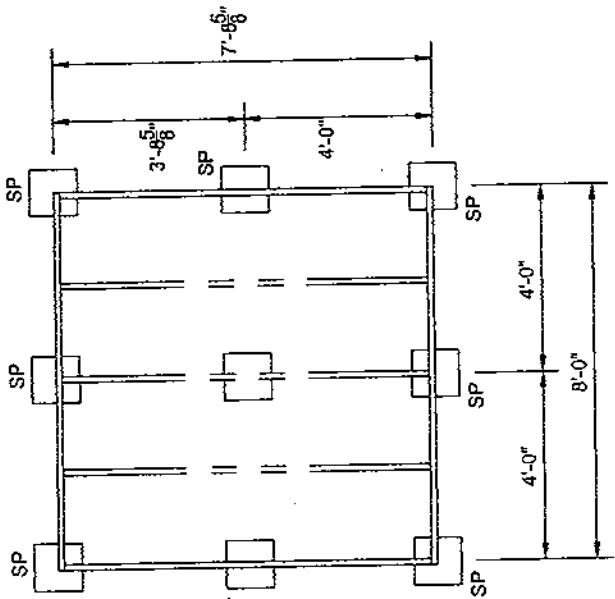

WOOD FLOOR LAYOUT

Exhibit B 3 of 8

NOTE:

1.) ONLY THE PIERS INDICATED WITH SP ARE REQUIRED TO HAVE SIMPSON STRONG TIES

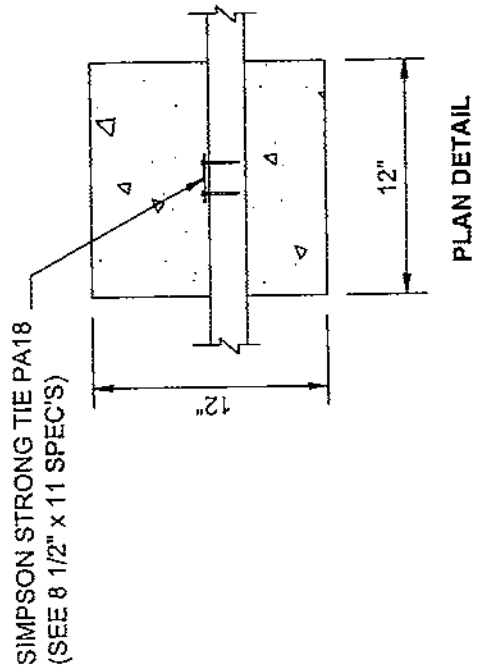
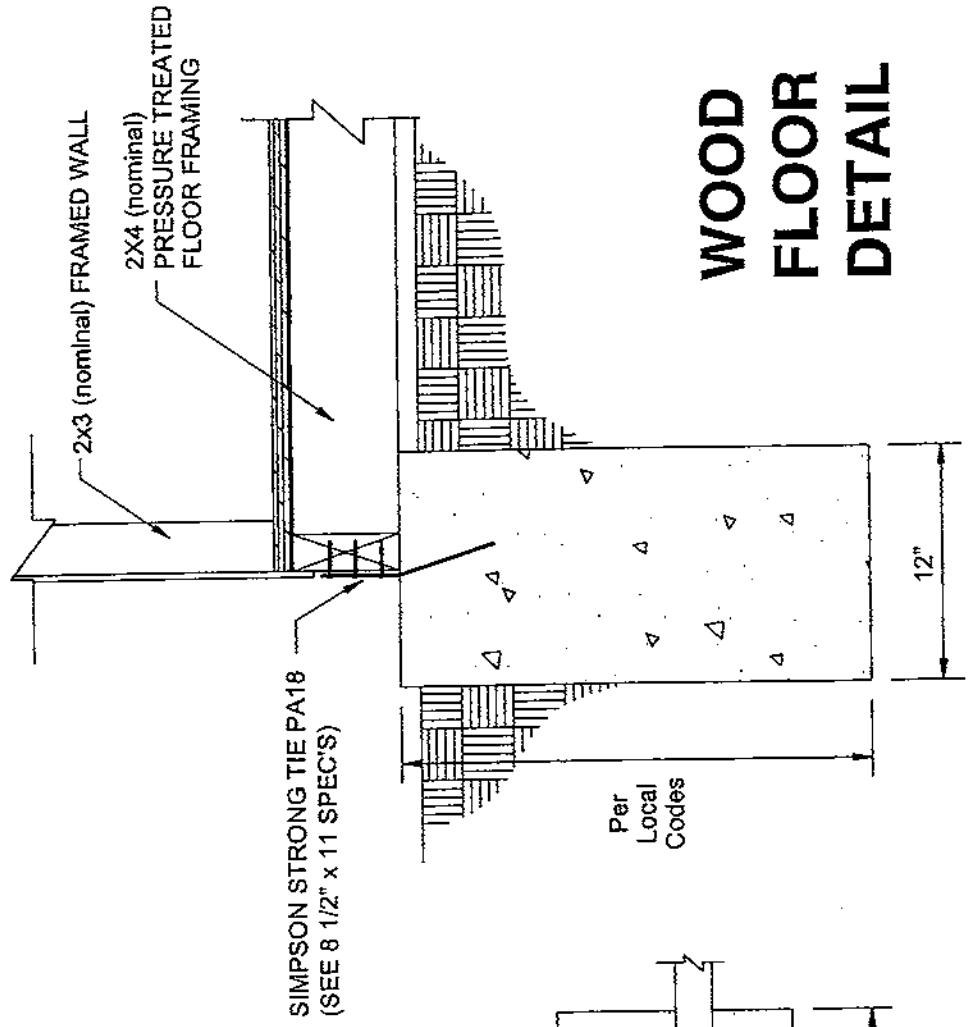

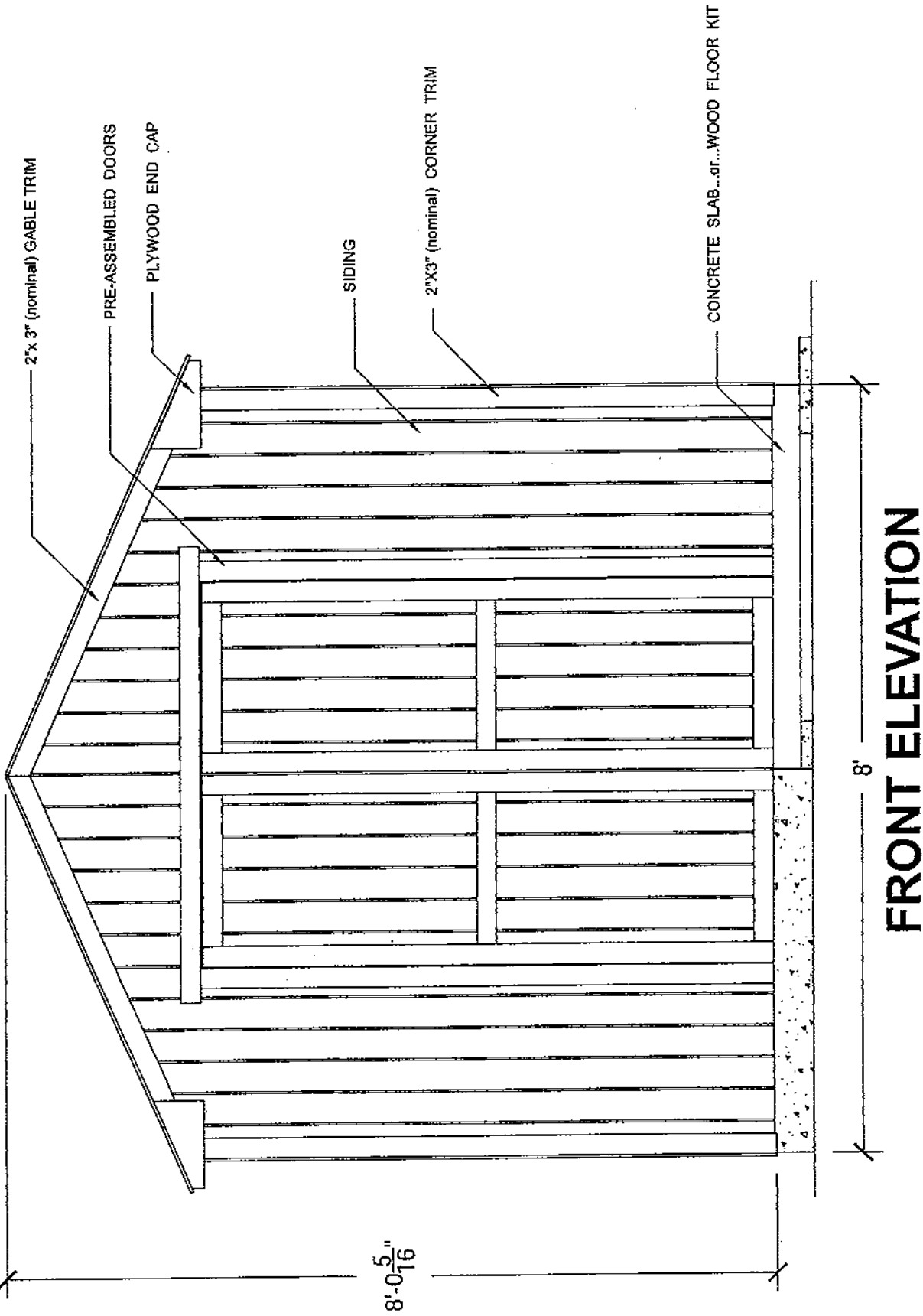

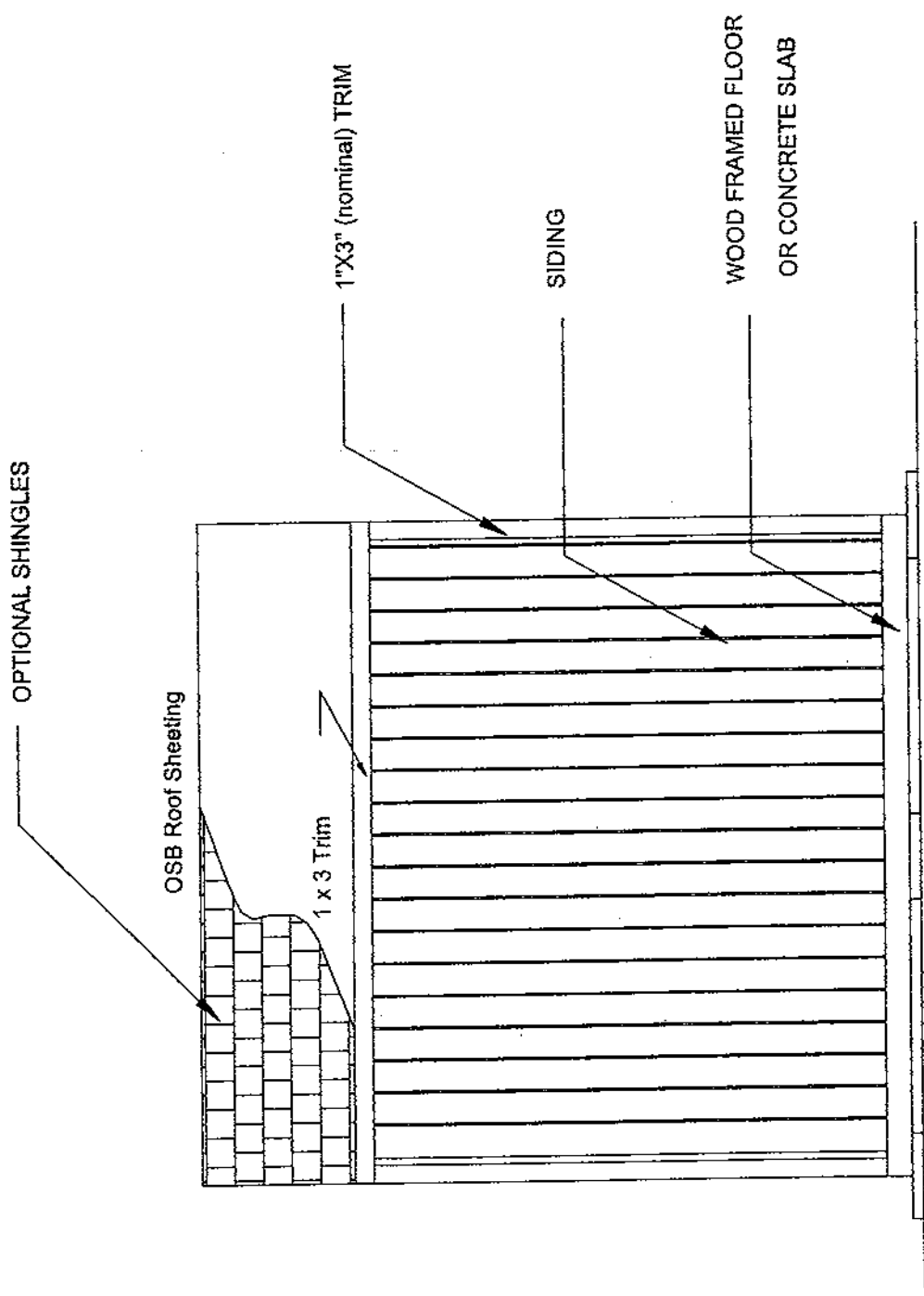

LEFT ELEVATION

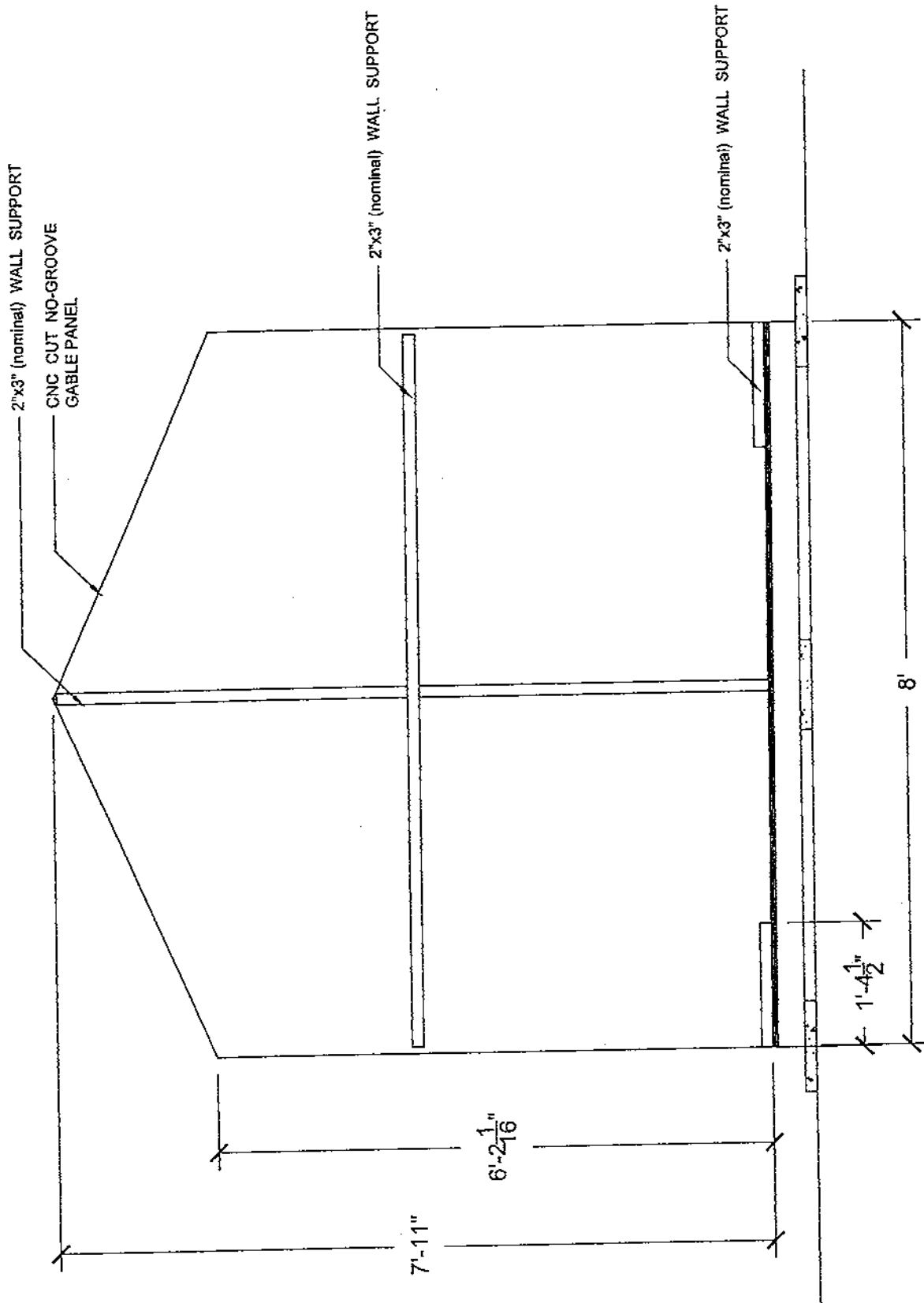

BACK WALL FRAMING

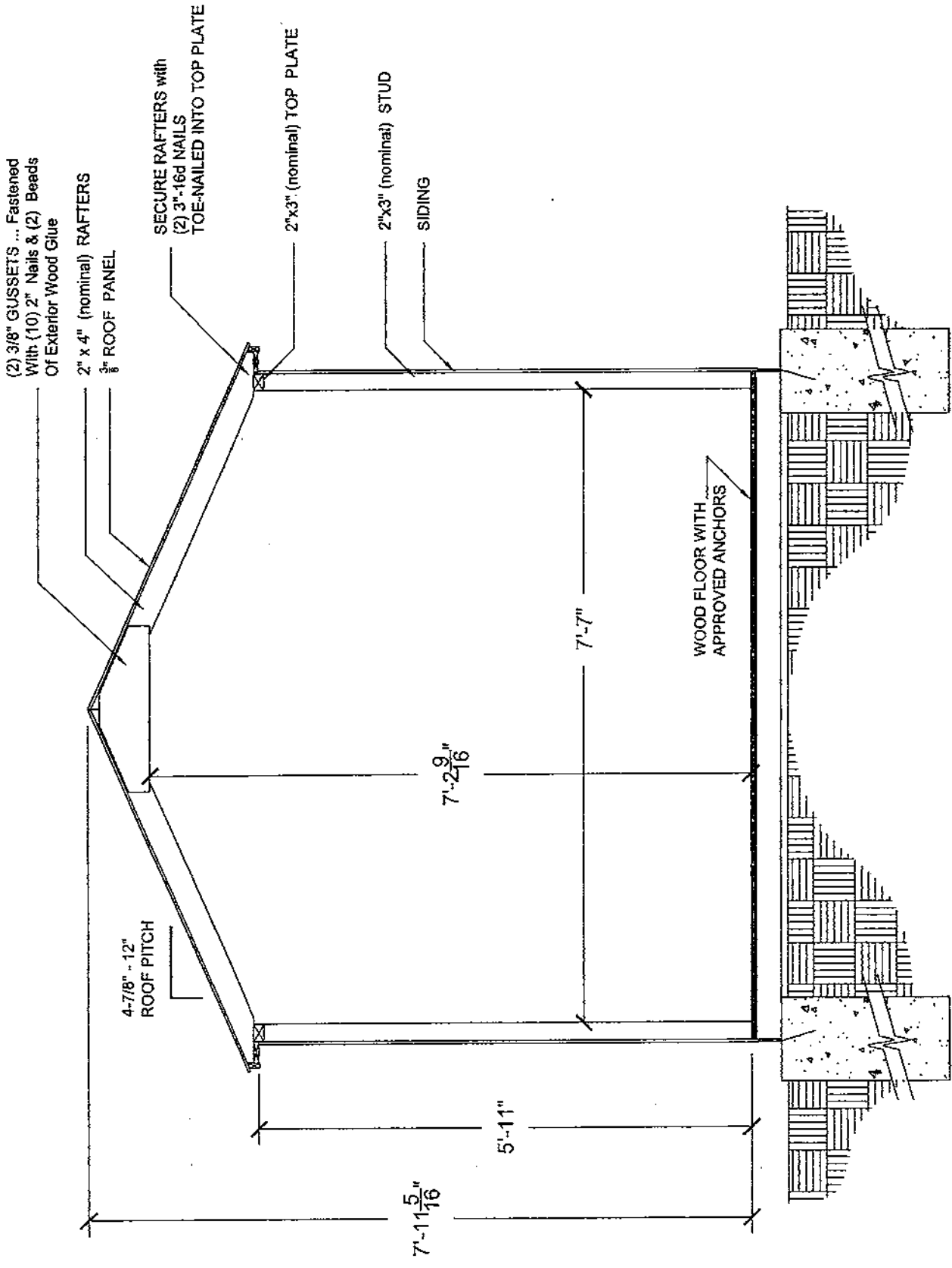

SECTION DETAIL

- NOTES: 1) The Roof System of this 8 ft. wide Gable style building has a live load capacity of 45 PSF. The equivalent ground snow load per ANCE 7-98 is 88 PSF which exceeds the 17.3 PSF pressure for a 110 mph wind per ASCE 7-98.
- 2) This plan supplements assembly instructions.

STRUCTURAL ANALYSIS:

f b = 1200 PSC
 f v = 80 psi
 Sx 2"x3" = 1.56 in Area = 3.75 in
 Dead Load = 4 PSF (Roof)
 Max Rafter Moment = fb Sx/12=306 ft.lb.
 Max Rafter Shear = 80x3.75=300 lb.
 Max Stud Moment = 156 ft. lb.

WALL SYSTEM:

1) Studs 2x3@24"cc L=3.3ft. w=8M/L2=114PLF=57 PSF
 2) Wind Loading V = 110 mph EXP 1
 Kz=0.37 Gh=1.65 GCpl=-0.25
 I=0.95 Cp=0.8
 Velocity Pressure=8z=.00256Kz(IV) =10.3PSF
 Design Pressure=P=qfGhCp-(qhGCpl)=16.2PSF
 ok<57PSF

ROOF SYSTEM:

1) Rafters 2x4@2'cc w=8M/L2 = 76PLF=45 PSF-4
 2) Rafter Shear w=2V/L = 117 PLF=92 PSF-4
 3) Sheathing w=45PSF-4=45psf
 4) Ground Snow Load: Ref ASCE 7-98
 Ps=45PSF I=0.8
 Cs=0.95 Ce=0.8
 Ct=1.2 Pf=45/0.95=47.4PSF
 Pg=PF/1.7CeCtI=88 PSF Ground Snow Capacity

10' Marco Series Gambrel Building

Engineering Building
Plans for 10x8, 10x12 and 10x16

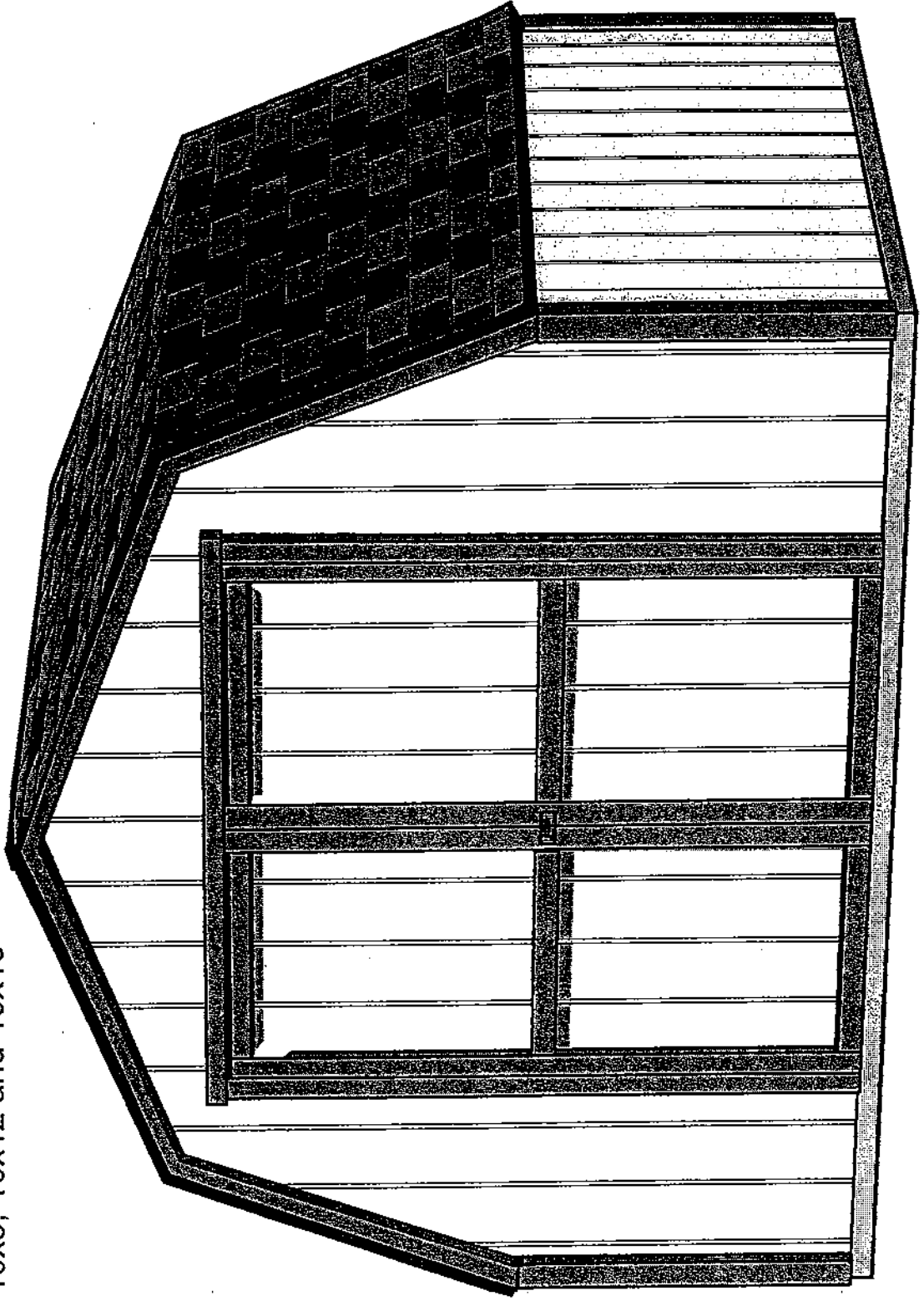

10'x12'

Slab size is 10' x 11' 8-5/8"

10'x16'

Slab size is 10' x 15' 8-5/8"

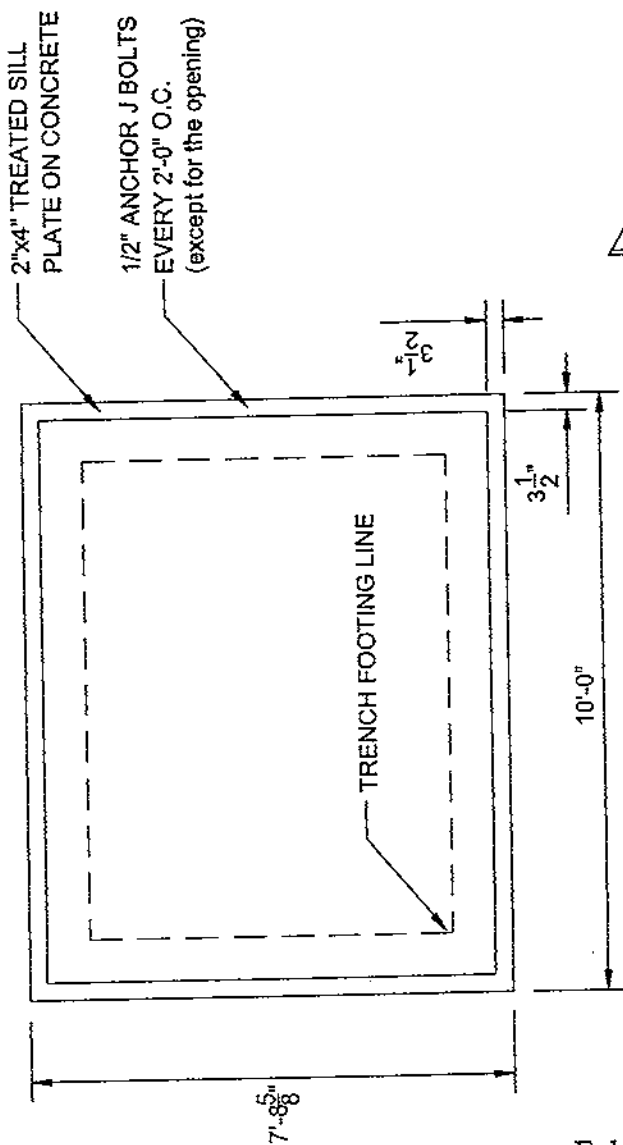

SLAB LAYOUT

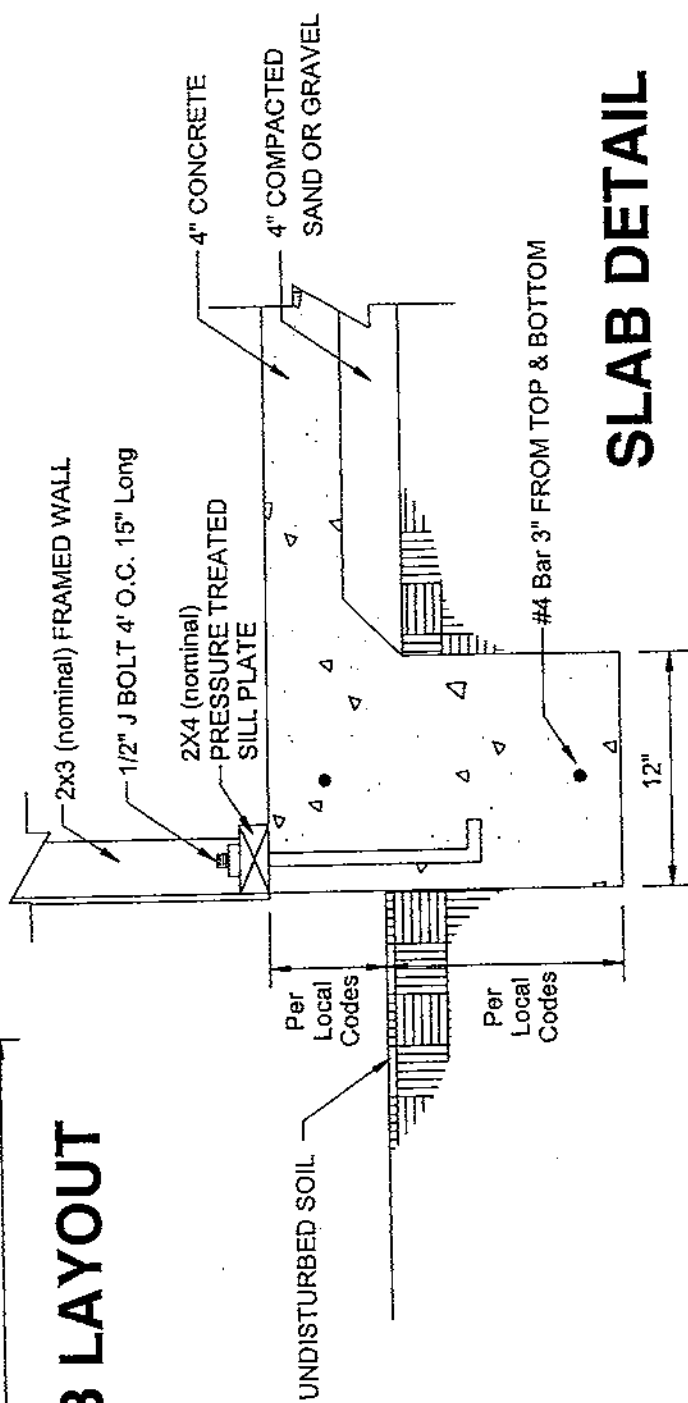

SLAB DETAIL

NOTE:

1.) ONLY THE PIERS INDICATED WITH SP ARE REQUIRED TO HAVE SIMPSON STRONG TIES

10'X12'

Wood Floor size is 10' x 11' 8-5/8"

10'X16'

Wood Floor size is 10' x 15' 8-5/8"

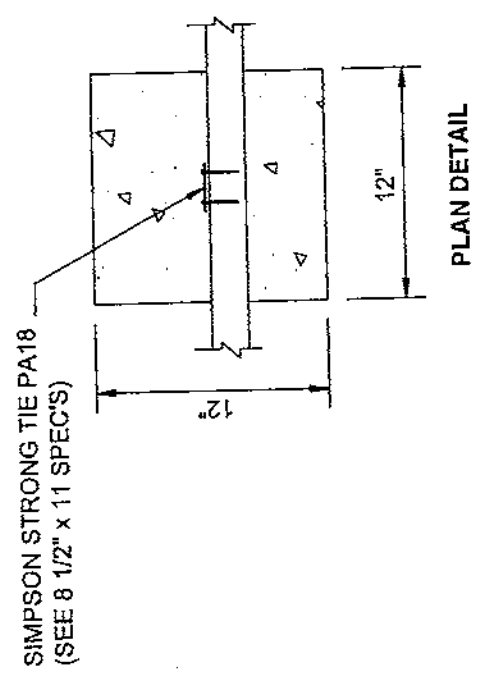
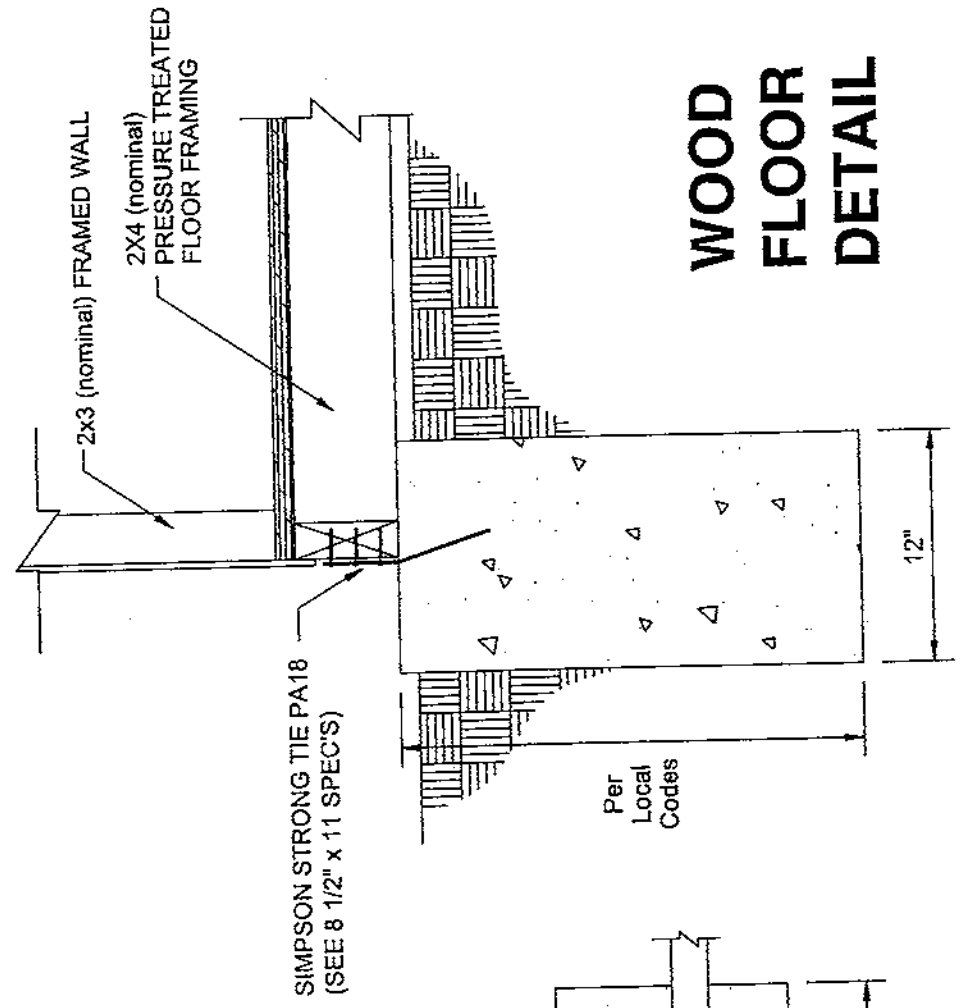
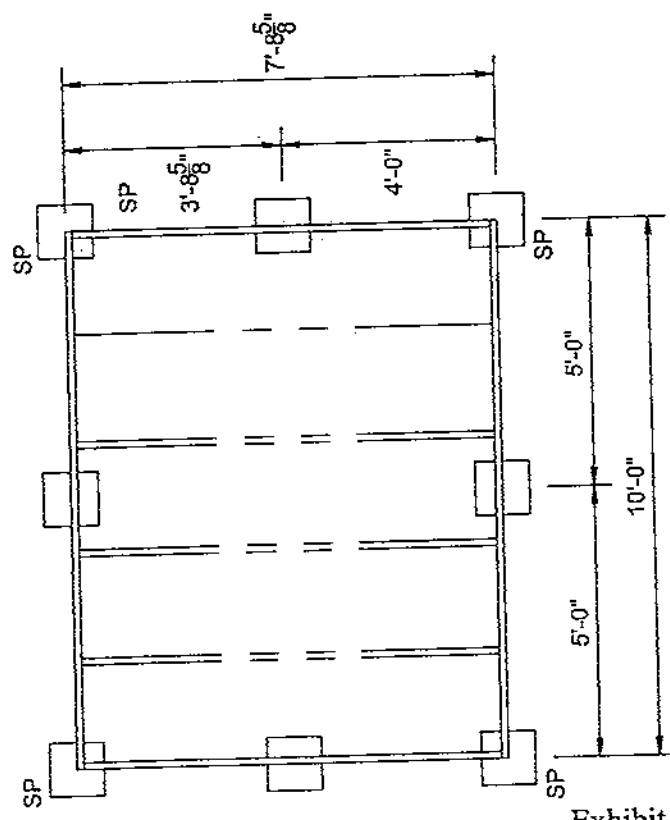

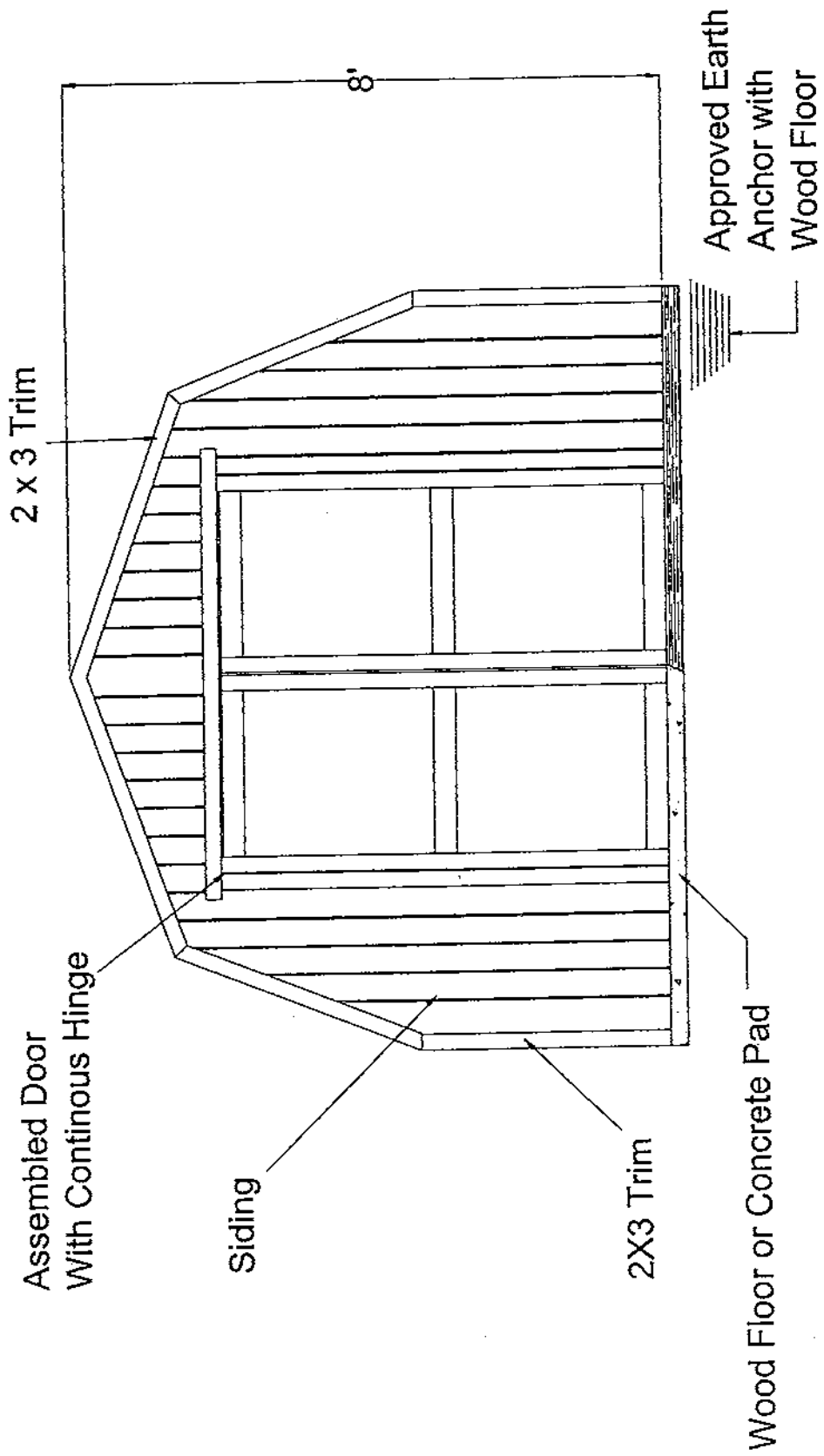

FRONT ELEVATION

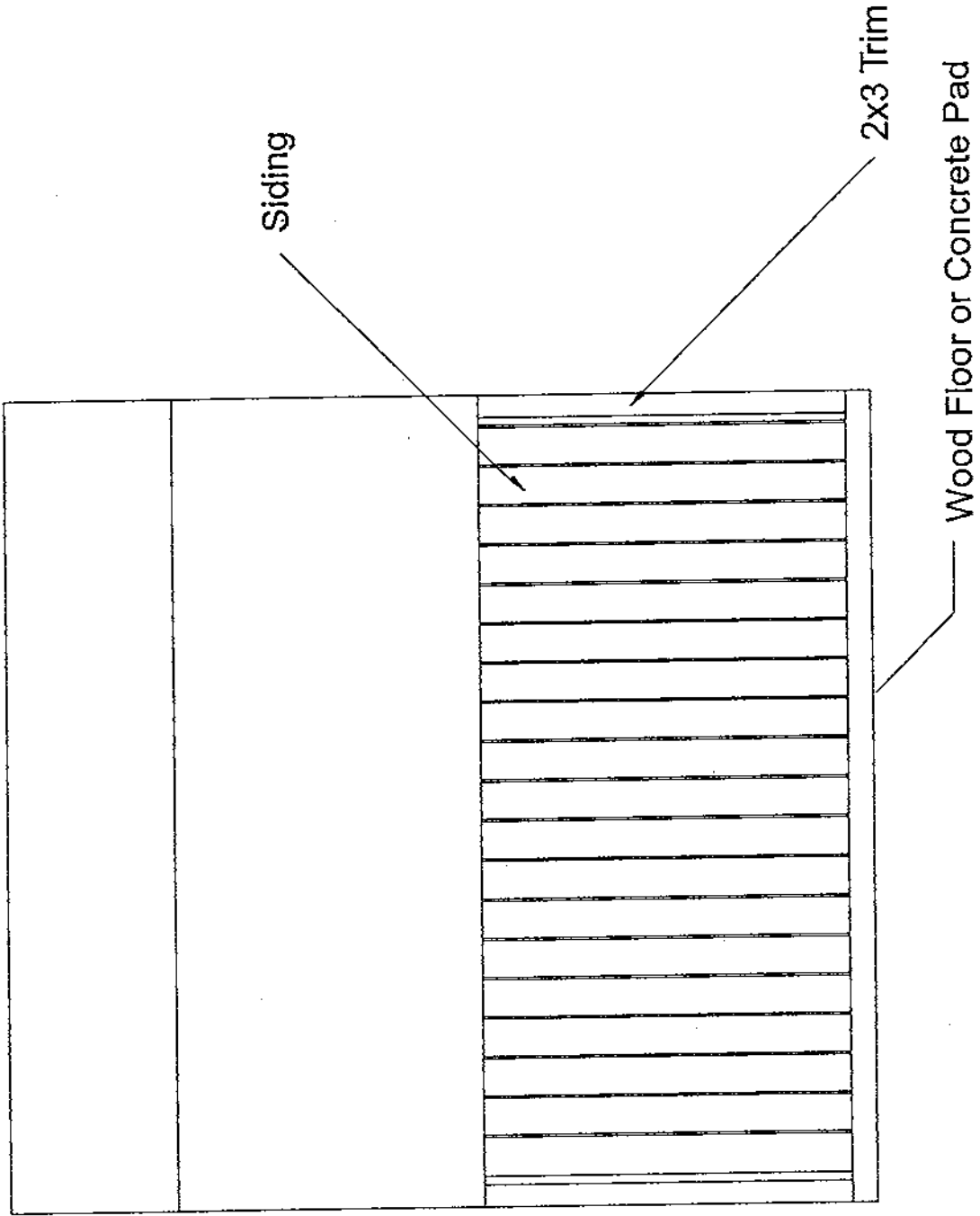

LEFT SIDE ELEVATION

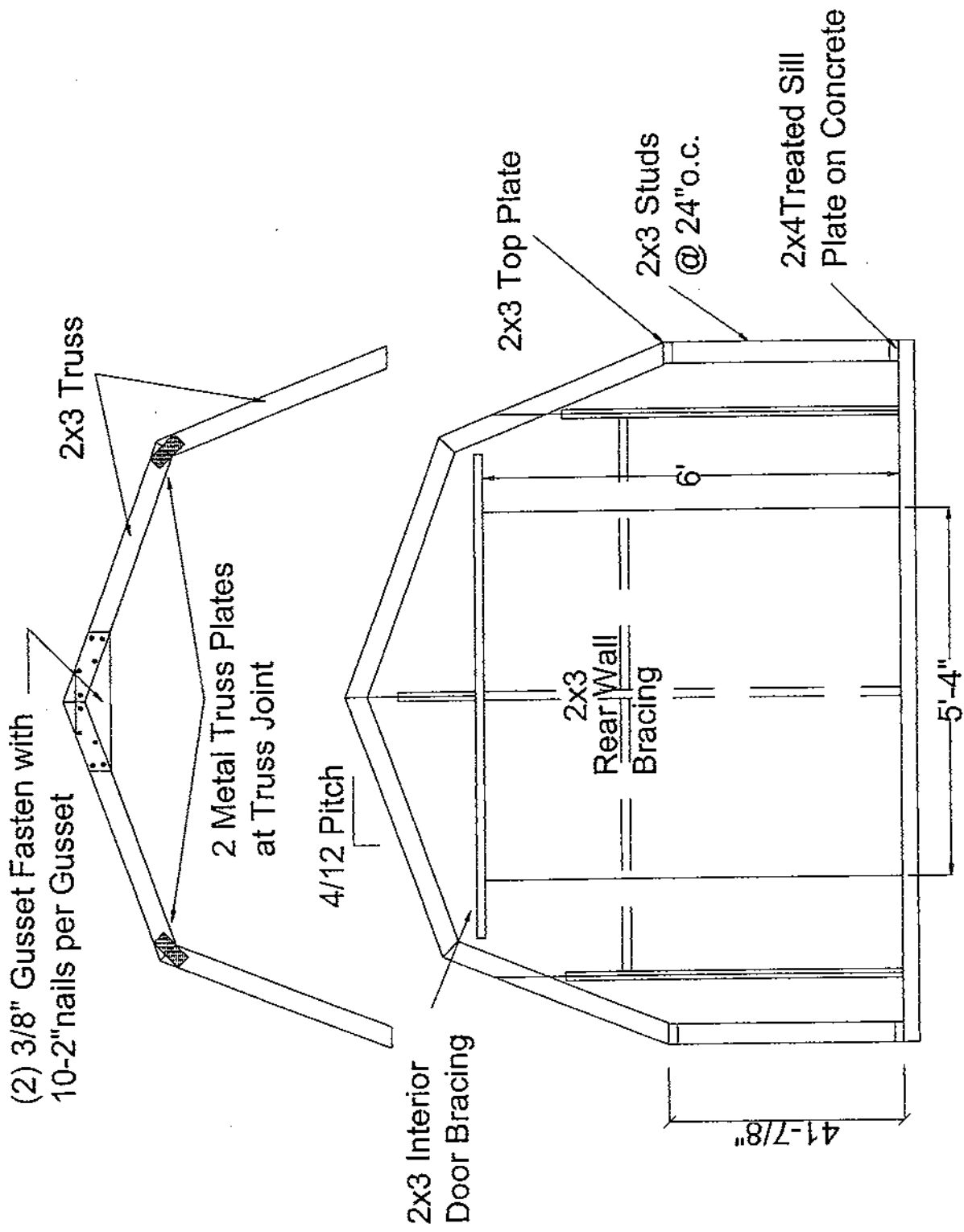

FRONT/REAR WALL FRAMING

O.S.B.
Roof Decking

2X4 Rafters
24" o.c.

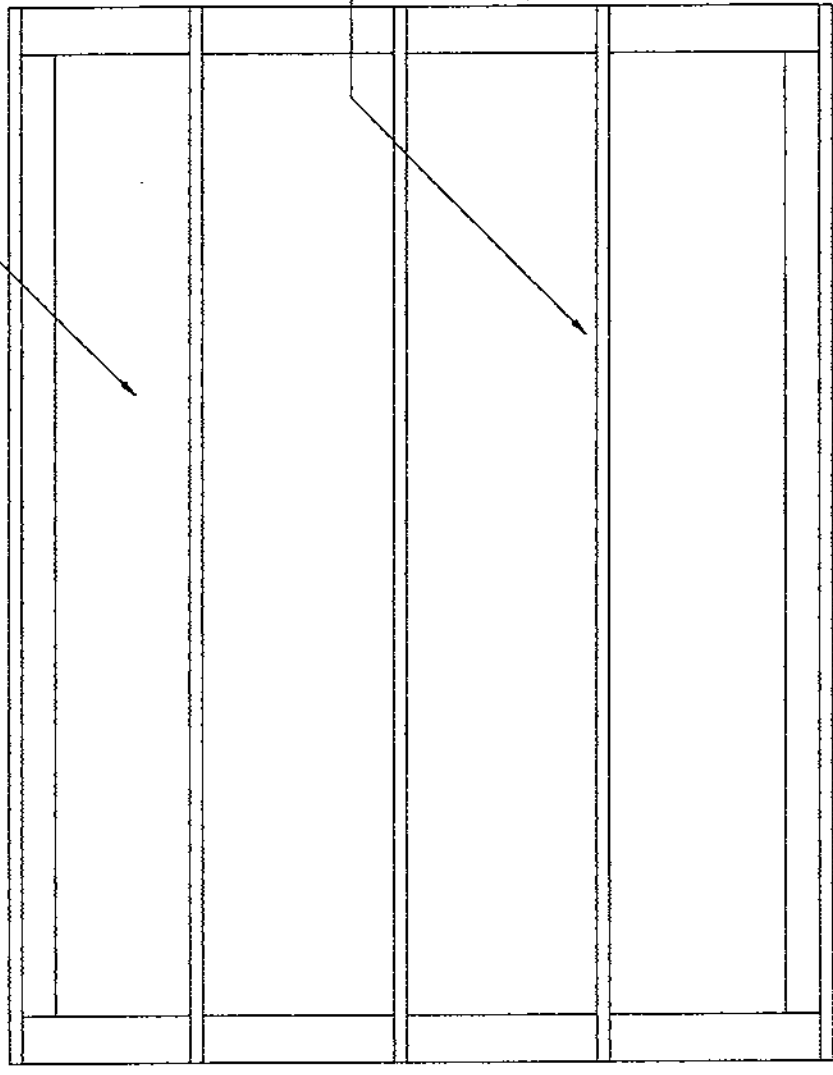

ROOF FRAMING

- NOTES: 1) The Roof System of this 10 ft. wide Gabrel style building has a live load capacity of 35 PSF. The equivalent ground snow load per ANCE 7-97 is 68 PSF which exceeds the 16.2 PSF pressure for a 110 mph wind per ASCE 7-97.
- 2) This plan supplements assembly instructions prepared by Handy Home Products.
- 3) Kits for extending the building in 4 ft. increments are identical in construction to the basic building.

STRUCTURAL ANALYSIS:

f b = 1200 PSC
 f v = 80 psi
 Sx 2"x3" = 1.56 in Area = 3.75 in
 DEAD LOAD:
 Max Rafter Moment = fb Sx/12=156 ft.lb.
 Max Rafter Shear = 80x3.75=300 lb.
 Max Stud Moment = 156 ft. lb.

WALL SYSTEM:

1) Studs 2x3@24"cc L=3.3ft. w=8M/L2=114PLF=57 PSF
 2) Wind Loading V = 110 mph EXP 1
 Kz=0.37 Gh=1.65 GCpl=-0.25
 I=0.95 Cp=0.8
 Velocity Pressure=8z=.00256Kz(IV) =10.3PSF
 Design Pressure=P=qfGhCp-(qhGCpl)=16.2PSF
 ok<57PSF

ROOF SYSTEM:

1) Rafters 2x3@2'cc w=8M/L2 = 78PLF=39 PSF-4
 2) Rafter Shear w=2V/L = 150 PLF=75 PSF-4
 3) Sheathing w=49PSF-4=45psf
 4) Ground Snow Load: Ref ASCE 7-97
 Ps=35PSF I=0.8
 Cs=0.95 Ce=0.8
 Ct=1.2 Pf=35/0.95=36PSF
 Pg=PF/.7CeCtI=68 PSF Ground Snow Capacity

10' Marco Series Gable Building

Engineering Building
Plans

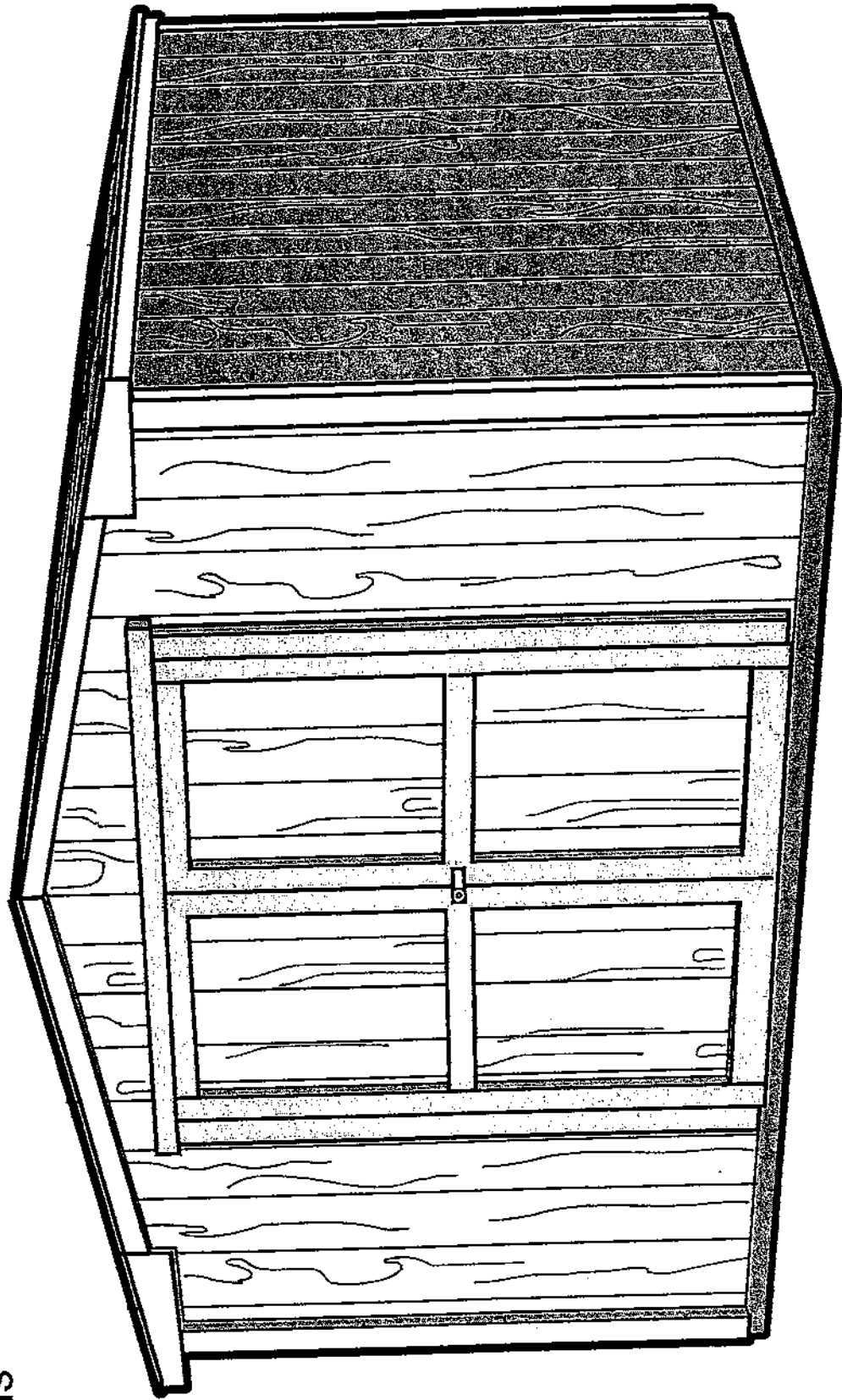

Exhibit D 1 of 8

10'x12'

Slab size is 10' x 11' 8-5/8"

10'x16'

Slab size is 10' x 15' 8-5/8"

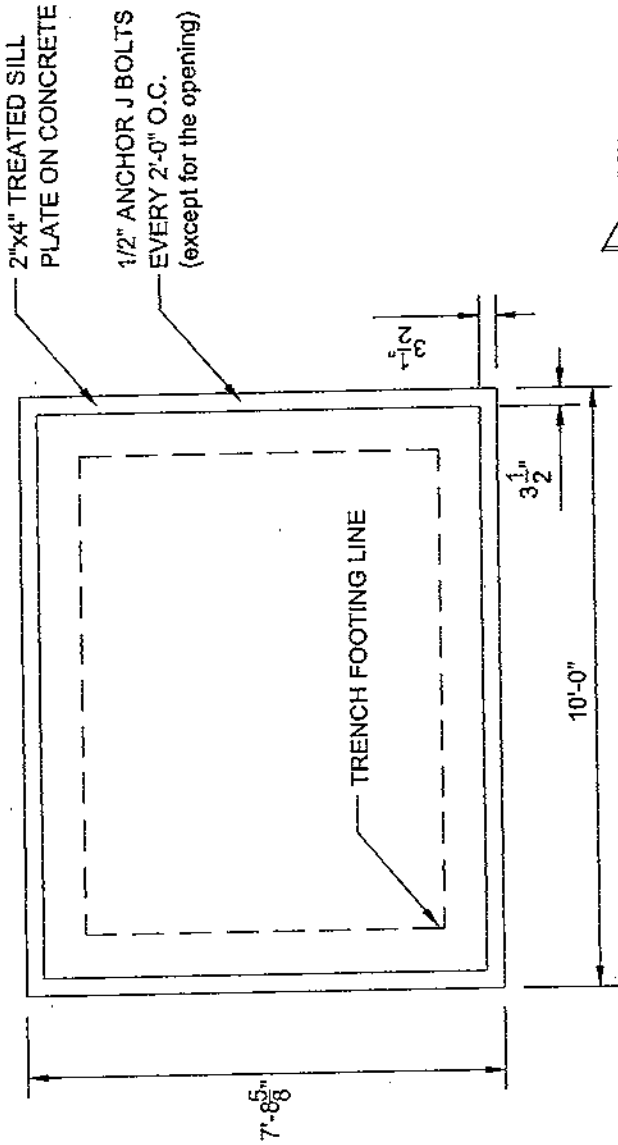

SLAB LAYOUT

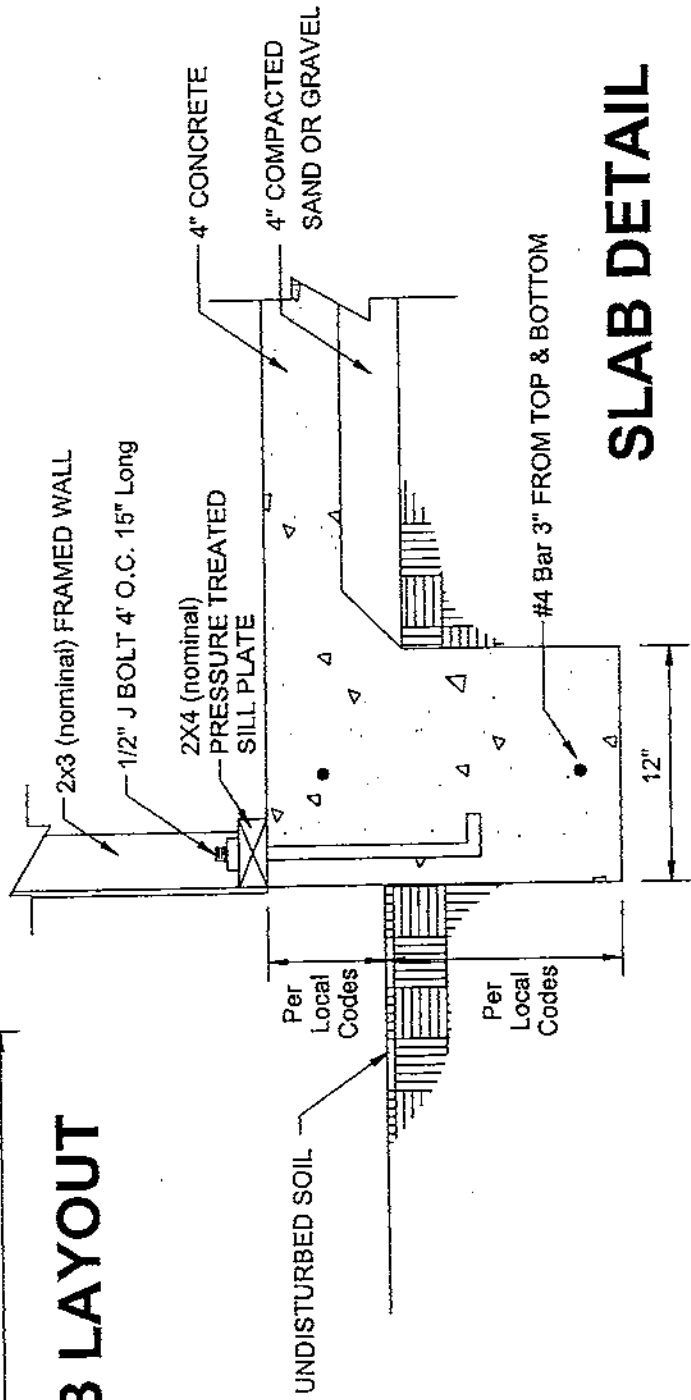

SLAB DETAIL

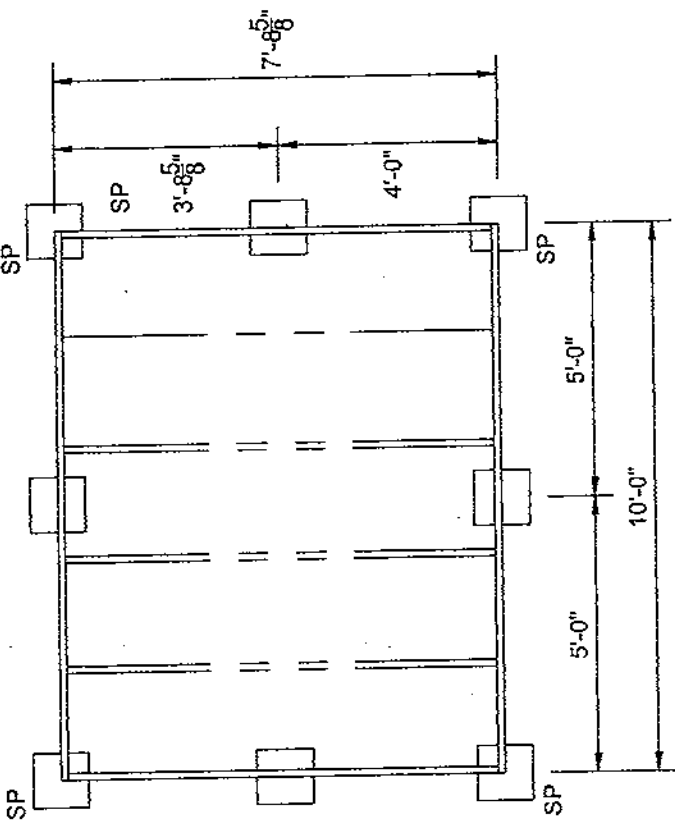

WOOD FLOOR LAYOUT

Exhibit D 3 of 8

SIMPSON STRONG TIE PA18
(SEE 8 1/2" x 11 SPECS)

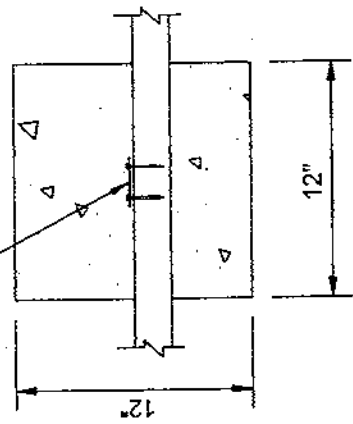

Per
Local
Codes

PLAN DETAIL

NOTE:

1.) ONLY THE PIERS INDICATED WITH SP ARE
REQUIRED TO HAVE SIMPSON STRONG TIES

10'x12'

Wood Floor size is 10' x 11' 8-5/8"

10'x16'

Wood Floor size is 10' x 15' 8-5/8"

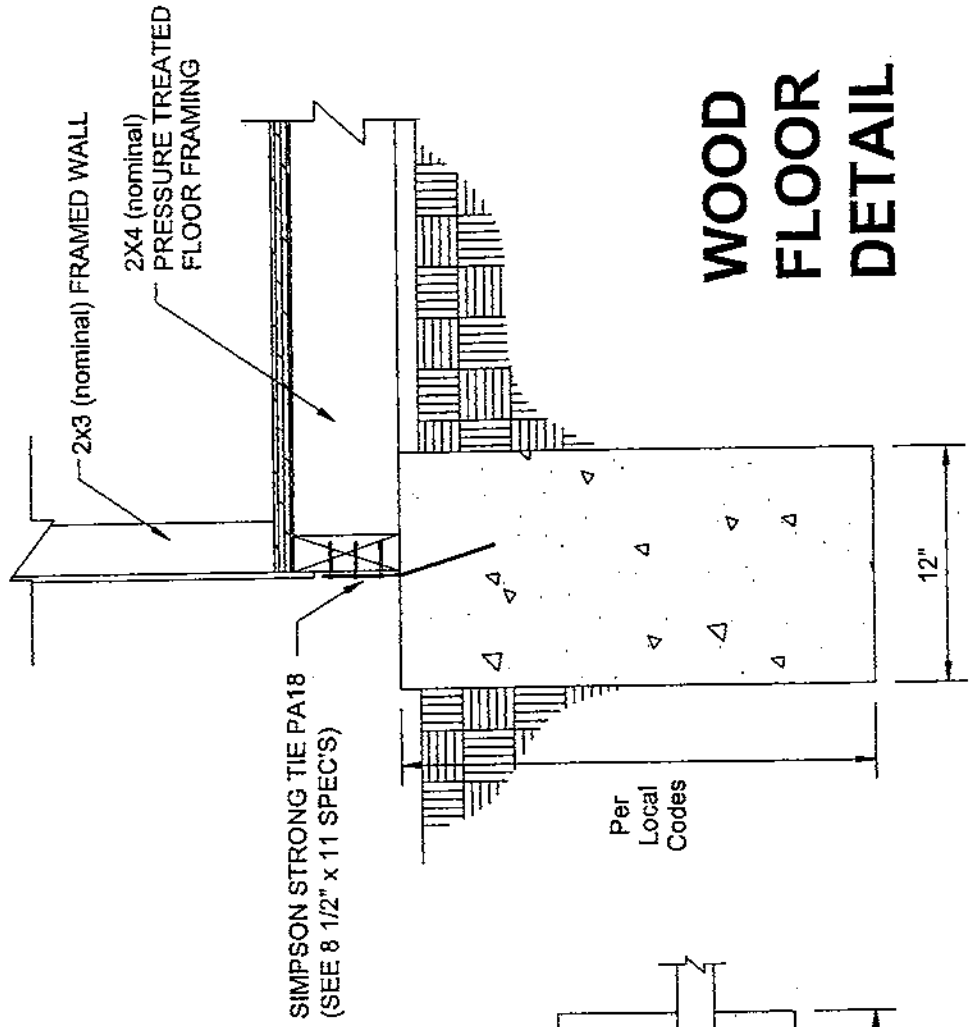

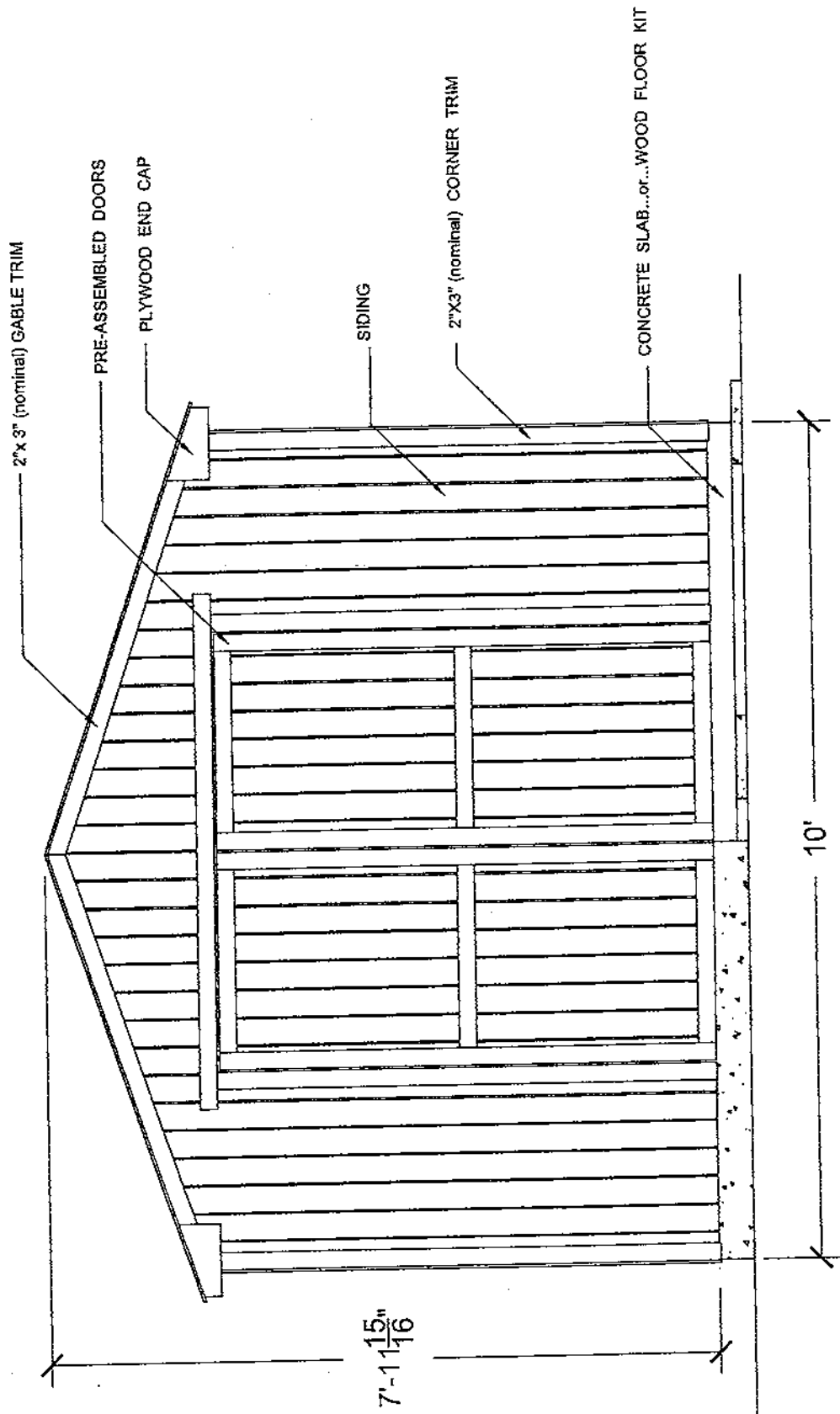

FRONT ELEVATION

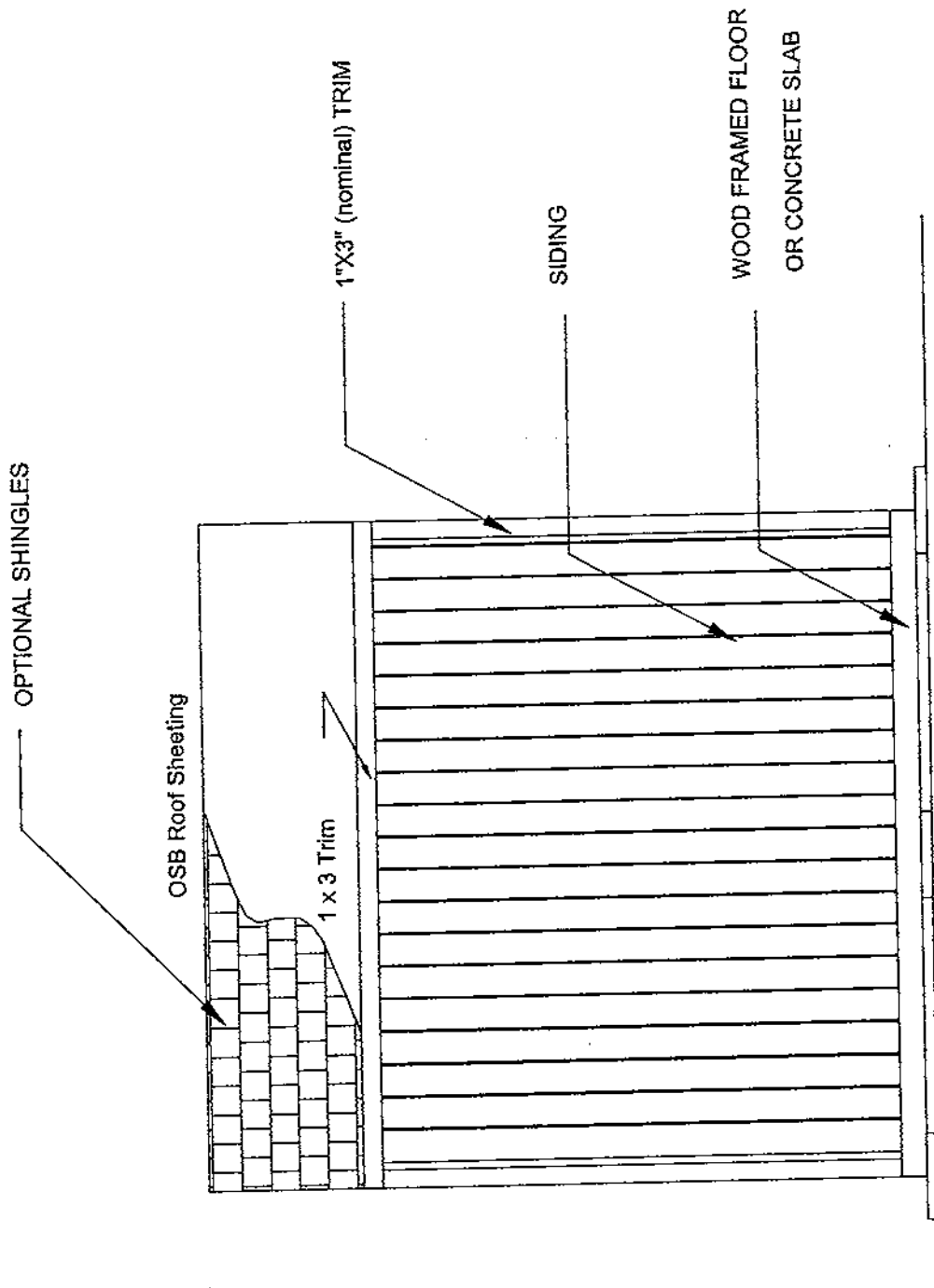

LEFT ELEVATION

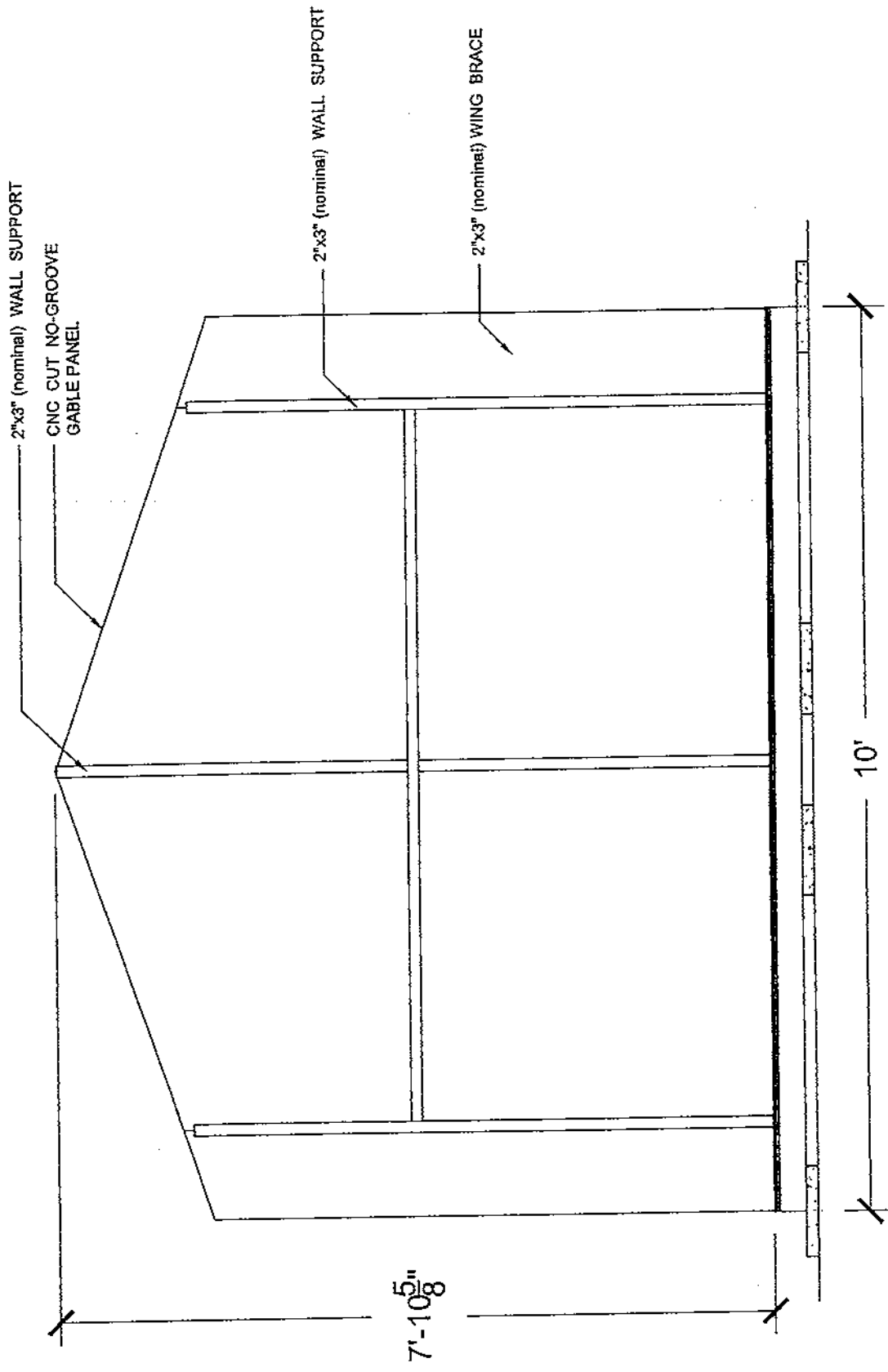

BACK WALL FRAMING

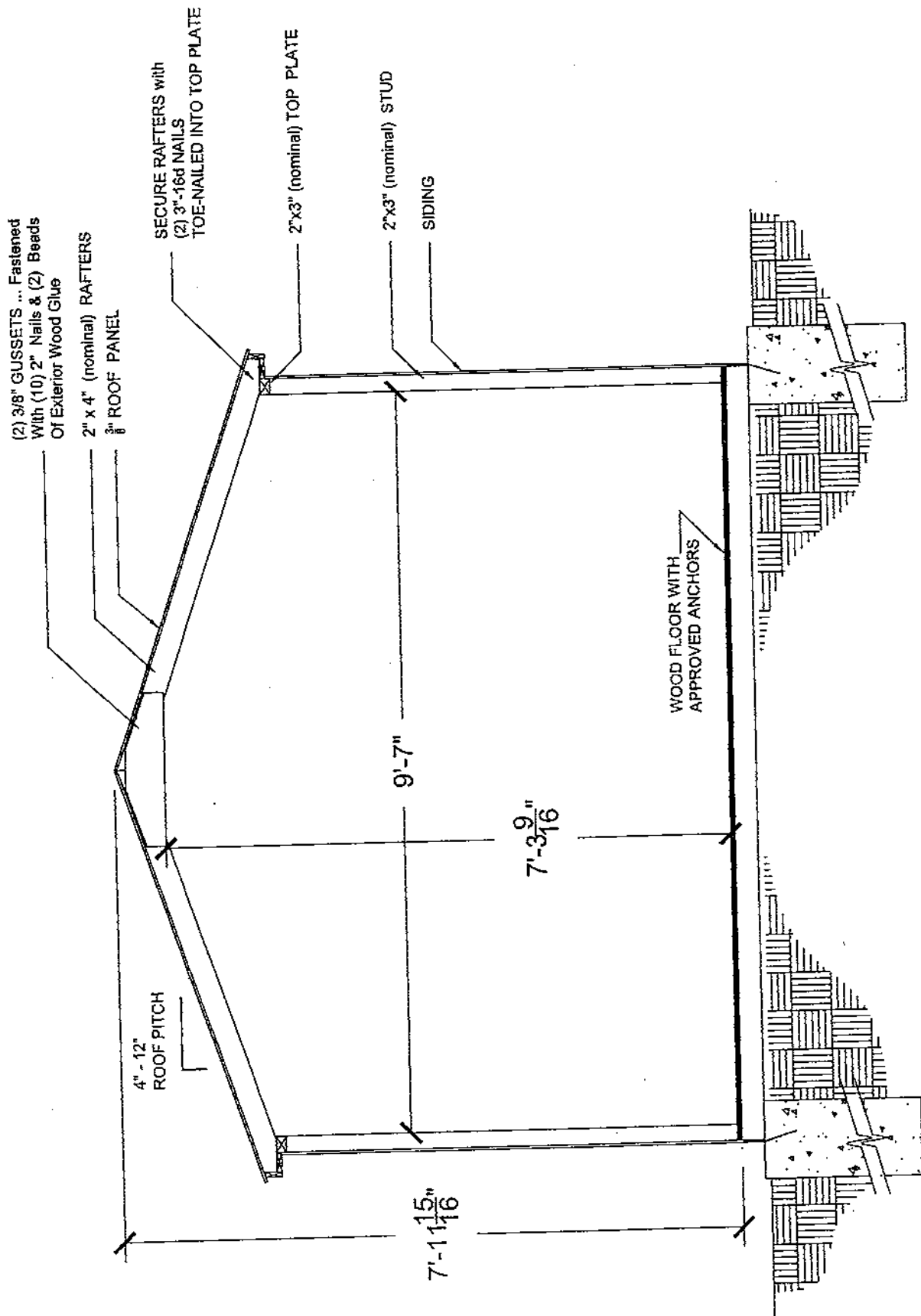

SECTION DETAIL

- NOTES: 1) The Roof System of this 10 ft. wide Gable style building has a live load capacity of 45 PSF. The equivalent ground snow load per ANCE 7-98 is 88 PSF which exceeds the 17.3 PSF pressure for a 110 mph wind per ASCE 7-98.
- 2) This plan supplements assembly instructions prepared by Handy Home Products.

STRUCTURAL ANALYSIS:

f b = 1200 PSC
 f v = 80 psi
 Sx 2"x3" = 1.56 in Area = 3.75 in
 Dead Load = 4 PSF (Roof)
 Max Rafter Moment = fb Sx/12=306 ft.lb.
 Max Rafter Shear = 80x3.75=300 lb.

Max Stud Moment = 156 ft. lb.

WALL SYSTEM:

1) Studs 2x3@24"cc L=3.3ft. w=8M/L2=114PLF=57 PSF
 2) Wind Loading V = 110 mph EXP 1
 Kz=0.37 Gh=1.65 GCpl=-0.25
 I=0.95 Cp=0.8
 Velocity Pressure=8z=.00256Kz(V) =10.3PSF
 Design Pressure=P=qfGhCp-(qhGCpl)=16.2PSF
 ok<57PSF

ROOF SYSTEM:

1) Rafters 2x4@2'cc w=8M/L2 = 76PLF=45 PSF-4
 2) Rafter Shear w=2V/L = 117 PLF=92 PSF-4
 3) Sheathing w=45PSF-4=45psf
 4) Ground Snow Load: Ref ASCE 7-98
 Ps=45PSF I=0.8
 Cs=0.95 Ce=0.8
 Ct=1.2 Pf=45/0.95=47.4PSF
 Pg=PF/1.7CeCtI=88 PSF Ground Snow Capacity